

Worldwide supplier of high quality electronic components

NTE[®]
ELECTRONICS, INC.

TEST LEADS & CLIPS

- Alligator, Crocodile, Plier, & Spring Type Clips
- Probes, Sprung Hooks, & Cable Piercers
- Panel Sockets
- Spade Terminals
- Self Assembly Plugs, Sockets, & Cables
- Cable Assemblies
- OEM Safety Test Lead Sets
- OEM Fused Probe Sets
- Modular Test Lead Sets
- Multi-Pin Connector Test Lead Sets
- Automotive Kits & Accessories



Compliant product now available on most items.

ECG[®]

Now part of the NTE family

2ND EDITION

www.nteinc.com

CONTENTS

CROSS REFERENCE

	<u>Page No.</u>
Special Cross Reference Notes	48
By Manufacturer	49-51
By Part Number	52-54

PRODUCT INDEX

	<u>Page No.</u>
Clips	
Alligator Type	2-12
Crocodile Type	29-30
Plier Type	22-24
Spring Type	13-21
Test Leads	25-28
Probes	31-34
Sprung Hooks	33
Panel Sockets, 4mm	35
Spade Terminals & Adaptors	36-37
Self Assembly Plugs & Sockets	38-40
Test Lead Kits	41-42
Automotive Test Lead Kits & Accesories	43-45
Miscellaneous Accessories	46-47
Cable & Extension Cable Reels	48

NUMERIC INDEX (See Note)

NTE Type	Pg No.	NTE Type	Pg No.	NTE Type	Pg No.	NTE Type	Pg No.	NTE Type	Pg No.
72-001	46	72-040	35	72-089	42	72-123-KIT3 ...	2	72-151-KIT	6
72-002	46	72-041	35	72-090	27	72-124	3	72-152-X	8
72-003	48	72-042	35	72-091	44	72-124-KIT1 ...	3	72-152-KIT	8
72-003-12	48	72-043	35	72-092	44	72-124-KIT2 ...	3	72-153	6
72-004	48	72-044	35	72-093	27	72-124-KIT3 ...	3	72-153-KIT	6
72-004-12	48	72-045	35	72-094	24	72-125	2	72-154	6
72-005	48	72-046	35	72-095	24	72-125-KIT1 ...	3	72-154-KIT	7
72-005-12	48	72-047	35	72-096	11	72-125-KIT2 ...	3	72-155	7
72-006	48	72-048	35	72-096-KIT	12	72-125-KIT3 ...	3	72-155-KIT	7
72-006-12	48	72-049	31	72-097	26	72-126	4	72-156	7
72-007	48	72-050	31	72-098	12	72-127-X	3	72-156-KIT	7
72-007-12	48	72-050-KIT	31	72-099B	11	72-128-X	2	72-157-X	8
72-008	48	72-051	36	72-099R	11	72-129	4	72-158-X	9
72-008-12	48	72-052	36	72-100	45	72-129-KIT	4	72-158-KIT	9
72-009	47	72-052-KIT	36	72-101	46	72-130	4	72-159	9
72-010	32	72-053	29	72-102	48	72-130-KIT	4	72-159-KIT1 ..	10
72-011	32	72-054	29	72-111	47	72-131-X	5	72-159-KIT2 ..	10
72-011-KIT	32	72-054-KIT	29	72-112-X	22	72-132-X	22	72-159-KIT3 ..	10
72-012	31	72-055	29	72-113	13	72-132-KIT	22	72-160	9
72-013	31	72-056	29	72-113PS	13	72-133	22	72-160-KIT1 ..	10
72-013-KIT	31	72-056-KIT	29	72-113-KIT1 ...	13	72-133-X	22	72-160-KIT2 ...	10
72-014	31	72-057	29	72-113-KIT2 ...	13	72-134	22	72-160-KIT3 ...	10
72-015	31	72-058	29	72-113-KIT3 ...	13	72-134X	22	72-161-X	10
72-015-KIT	31	72-058-KIT	29	72-114	13	72-135-X	23	72-162	24
72-017	33	72-059	30	72-114PS	13	72-136	17	72-163	19
72-018	32	72-060	30	72-114-KIT1 ...	14	72-136-KIT	17	72-163-KIT	20
72-019	32	72-060-KIT	30	72-114-KIT2 ...	14	72-137	17	72-163-KIT1 ...	20
72-019-KIT	32	72-061	38	72-114-KIT3 ...	14	72-137-KIT	18	72-163-KIT2 ...	20
72-020	32	72-062	38	72-115-X	13	72-138-X	23	72-163-KIT3 ...	20
72-021	32	72-063	39	72-116	14	72-138-KIT	23	72-164	20
72-021-KIT	32	72-064	39	74-116PS	14	72-139	23	72-164-KIT1 ...	20
72-022	33	72-065	25	72-116-KIT	14	72-139-KIT	23	72-164-KIT2 ...	20
72-023	33	72-066	25	72-117	14	72-140	23	72-164-KIT3 ...	20
72-023-KIT	33	72-067	25	72-117-KIT1 ...	15	72-140-KIT	23	72-165-X	20
72-024	33	72-068	25	72-117-KIT2 ...	15	72-141	23	72-166-X	11
72-025	33	72-070	26	72-117-KIT3 ...	15	72-141-KIT	23	72-167	10
72-025-KIT	33	72-071	26	72-118	15	72-142-X	24	72-168	10
72-026	36	72-072	41	72-118-KIT1 ...	15	72-143-X	18	72-168-KIT	11
72-027	36	72-073	43	72-118-KIT2 ...	15	72-144	18	72-173	21
72-027-KIT	36	72-074	41	72-118-KIT3 ...	15	72-144-KIT	18	72-173PS	21
72-028	36	72-075	42	72-119-X	15	72-145	19	72-174	21
72-029	36	72-076	28	72-120	16	72-145-KIT	19	72-174PS	21
72-029-KIT	36	72-077	26	72-120-KIT1 ...	16	72-146-X	19	72-175	28
72-030	37	72-078	27	72-120-KIT2 ...	16	72-147	47	72-176-X	21
72-031	38	72-079	43	72-120-KIT3 ...	16	72-148	5	72-177-X	34
72-032	38	72-080	45	72-121	16	72-148-KIT1 ...	8	72-178-X	34
72-033	38	72-082	46	72-121-KIT1 ...	17	72-148-KIT2 ...	8	72-179-X	39
72-034	38	72-083	46	72-121-KIT2 ...	17	72-148-KIT3 ...	8	72-180-X	34
72-035	39	72-084	46	72-121-KIT3 ...	17	72-149	5	72-181	12
72-036	39	72-085	48	72-122-X	16	72-149-KIT	5	72-182-X	40
72-037	35	72-086	46	72-123	2	72-150-X	9		
72-038	35	72-087	46	72-123-KIT1 ...	2	72-150-KIT	9		
72-039	35	72-088	46	72-123-KIT2 ...	2	72-151	6		

NOTE: Replace "X" with 0 = Black, 2 = Red, 4 = Yellow, 5 = Green, 6 = Blue, 9 = White

Miniature Steel Alligator Clip, 5 Amp

Features

- Nickel Plated
- Crimp or Solder Connection
- Overall Length: 1.100" (27.9mm)
- Jaw Opening: .190" (4.8mm)

NTE Type No.	Description
72-123	Miniature Steel Alligator Clip



Miniature Solid Copper Alligator Clip, 5 Amp

Features

- Crimp or Solder Connection
- Overall Length: 1.100" (27.9mm)
- Jaw Opening: .190" (4.8mm)

NTE Type No.	Description
72-125	Miniature Solid Copper Alligator Clip



PVC Insulator

Features

- Fits 72-123, 72-124 & 72-125 Types
- Skin Tight Insulator Design
- Flexible PVC Composition
- Overall Length: 1.220" (30.9mm)

NTE Type No.	Description
72-128-0	PVC Insulator for 72-123 thru 72-125, Black
72-128-2	PVC Insulator for 72-123 thru 72-125, Red
NEW 72-128-4	PVC Insulator for 72-123 thru 72-125, Yellow
NEW 72-128-5	PVC Insulator for 72-123 thru 72-125, Green
NEW 72-128-6	PVC Insulator for 72-123 thru 72-125, Blue
NEW 72-128-9	PVC Insulator for 72-123 thru 72-125, White



72-123 Series Kits

Features

- 5 Amp Nickel Plated Miniature Alligator Clip
- Flexible PVC Composition Insulator

NTE Type No.	Kit Contains
72-123-KIT1	1 Pair of 72-123 Nickel Plated Mini Alligator Clips 1 Pair of 72-128-0 Black Insulators
72-123-KIT2	1 Pair of 72-123 Nickel Plated Mini Alligator Clips 1 Pair of 72-128-2 Red Insulators
NEW 72-123-KIT3	1 Pair of 72-123 Nickel Plated Mini Alligator Clips 1 Each of 72-128-0 (Black) and 72-128-2 (Red) Insulators

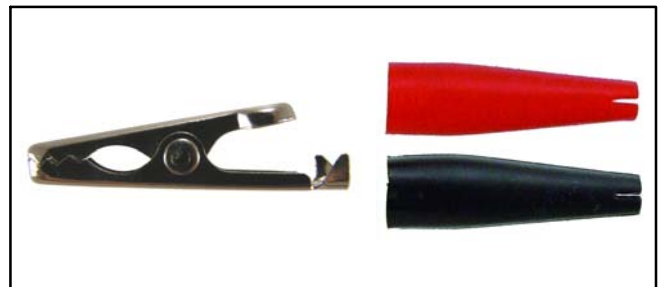

72-125 Series Kits

Features

- 5 Amp Solid Copper Miniature Alligator Clip
- Flexible PVC Composition Insulator

NTE Type No.	Kit Contains
72-125-KIT1	1 Pair of 72-125 Solid Copper Mini Alligator Clips 1 Pair of 72-128-0 Black Insulators
72-125-KIT2	1 Pair of 72-125 Solid Copper Mini Alligator Clips 1 Pair of 72-128-2 Red Insulators
NEW 72-125-KIT3	1 Pair of 72-125 Solid Copper Mini Alligator Clips 1 Each of 72-128-0 (Black) and 72-128-2 (Red) Insulators

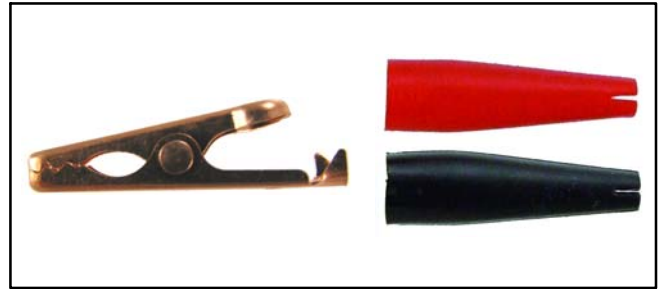

Mini Steel Alligator Clip w/Barrel, 5 Amp

Features

- Nickel Plated
- Crimp or Solder Connection Barrel Tail
- Overall Length: 1.250" (31.7mm)
- Jaw Opening: .190" (4.8mm)

NTE Type No.	Description
72-124	Miniature Steel Alligator Clip with Barrel



PVC Insulator

Features

- Fits 72-124
- Flexible PVC Composition
- Overall Length: 1.600" (42.9mm)

NTE Type No.	Description
72-127-0	PVC Insulator for 72-124 Series, Black
72-127-2	PVC Insulator for 72-124 Series, Red
NEW 72-127-4	PVC Insulator for 72-124 Series, Yellow
NEW 72-127-5	PVC Insulator for 72-124 Series, Green
NEW 72-127-6	PVC Insulator for 72-124 Series, Blue
NEW 72-127-9	PVC Insulator for 72-124 Series, White



72-124 Series Kits

Features

- 5 Amp Steel Miniature Alligator Clip with Barrel
- Flexible PVC Composition Insulator

NTE Type No.	Kit Contains
72-124-KIT1	1 Pair of 72-124 Mini Steel Alligator Clips w/Barrel 1 Pair of 72-127-0 Black Insulators
72-124-KIT2	1 Pair of 72-124 Mini Steel Alligator Clips w/Barrel 1 Pair of 72-127-2 Red Insulators
NEW 72-124-KIT3	1 Pair of 72-124 Mini Steel Alligator Clips w/Barrel 1 Each of 72-127-0 (Black) and 72-127-2 (Red) Insulators

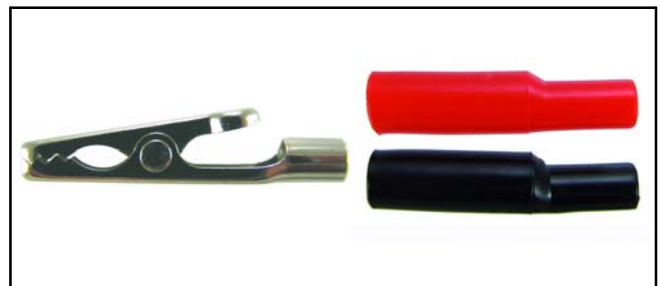

Mini Steel Alligator Clip w/Threaded Barrel, 5 Amp

Features

- Nickel Plated
- 6-32 UNC Threaded Barrel Connection
- Overall Length: 1.500" (38.1mm)
- Jaw Opening: .190" (4.8mm)

NTE Type No.	Description
72-126	Miniature Steel Alligator Clip with Threaded Barrel



Toothless Steel Alligator Clip, 5 Amp

Features

- Smooth Micro Tipped Jaws
- Crimp or Solder Connection
- Overall Length: 1.100" (27.9mm)
- Jaw Opening: .220" (5.58mm)

NTE Type No.	Description
72-129	Toothless Steel Alligator Clip



72-129 Series Kit

Features

- 5 Amp Toothless Steel Alligator Clip
- Flexible PVC Composition Insulator

NEW

NTE Type No.	Kit Contains
72-129-KIT	2 Pair of 72-129 Toothless Steel Alligator Clips 2 Pieces of 72-131-0 Black Insulators 2 Pieces of 72-131-2 Red Insulators

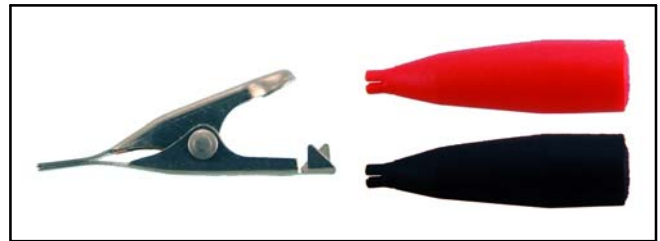

Toothless Solid Copper Alligator Clip, 5 Amp

Features

- Smooth Micro Tipped Jaws
- Crimp or Solder Connection
- Overall Length: 1.100" (27.9mm)
- Jaw Opening: .220" (5.58mm)

NTE Type No.	Description
72-130	Toothless Solid Copper Alligator Clip



72-130 Series Kit

Features

- 5 Amp Toothless Solid Copper Alligator Clip
- Flexible PVC Composition Insulator

NEW

NTE Type No.	Kit Contains
72-130-KIT	2 Pair of 72-130 Toothless Solid Copper Alligator Clips 2 Pieces of 72-131-0 Black Insulators 2 Pieces of 72-131-2 Red Insulators



PVC Insulator

Features

- Fits 72-129 & 72-130
- Skin Tight Insulator Design
- Flexible PVC Composition
- Overall Length: 1.250" (31.7mm)

NTE Type No.	Description
72-131-0	PVC Insulator for 72-129 & 72-130, Black
72-131-2	PVC Insulator for 72-129 & 72-130, Red
NEW 72-131-4	PVC Insulator for 72-129 & 72-130, Yellow
NEW 72-131-5	PVC Insulator for 72-129 & 72-130, Green
NEW 72-131-6	PVC Insulator for 72-129 & 72-130, Blue
NEW 72-131-9	PVC Insulator for 72-129 & 72-130, White



Steel Alligator Clip w/Barrel, 10 Amp

Features

- Nickel Plated
- Crimp/Solder or Banana Plug Connection
- Overall Length: 1.950" (49.5mm)
- Jaw Opening: .310" (7.87mm)

NTE Type No.	Description
72-148	Steel Alligator Clip with Barrel



Solid Copper Alligator Clip w/Barrel, 10 Amp

Features

- Crimp/Solder or Banana Plug Connection
- Overall Length: 1.950" (49.5mm)
- Jaw Opening: .310" (7.87mm)

NTE Type No.	Description
72-149	Solid Copper Alligator Clip with Barrel



72-149 Series Kit

Features

- 10 Amp Solid Copper Alligator Clip w/Barrel
- Flexible PVC Composition Insulator

NTE Type No.	Kit Contains
NEW 72-149-KIT	2 Pair of 72-149 Solid Copper Alligator Clips 2 Pieces of 72-157-0 Black Insulators 2 Pieces of 72-157-2 Red Insulators



Steel Alligator Clip w/Barrel & Screw, 10 Amp

Features

- Nickel Plated
- Screw Connection
- Overall Length: 1.950" (49.5mm)
- Jaw Opening: .310" (7.87mm)

NTE Type No.	Description
72-153	Steel Alligator Clip with Barrel & Screw



72-153 Series Kit

Features

- 10 Amp Steel Alligator Clip w/Barrel & Screw
- Flexible PVC Composition Insulator

NTE Type No.	Kit Contains
72-153-KIT	2 Pair of 72-153 Steel Alligator Clips 2 Pieces of 72-157-0 Black Insulators 2 Pieces of 72-157-2 Red Insulators



Solid Copper Alligator Clip w/Barrel & Screw, 10 Amp

Features

- Screw Connection
- Overall Length: 1.950" (49.5mm)
- Jaw Opening: .310" (7.87mm)

NTE Type No.	Description
72-151	Solid Copper Alligator Clip with Barrel & Screw



72-151 Series Kit

Features

- 10 Amp Solid Copper Alligator Clip w/Barrel & Screw
- Flexible PVC Composition Insulator

NTE Type No.	Kit Contains
72-151-KIT	2 Pair of 72-151 Solid Copper Alligator Clips 2 Pieces of 72-157-0 Black Insulators 2 Pieces of 72-157-2 Red Insulators



Steel Alligator Clip w/Threaded Barrel, 10 Amp

Features

- Nickel Plated
- 8-32 UNC Threaded Barrel Connection
- Overall Length: 2.125" (53.9mm)
- Jaw Opening: .310" (7.87mm)

NTE Type No.	Description
72-154	Steel Alligator Clip with Threaded Barrel



72-154 Series Kit

Features

- 10 Amp Steel Alligator Clip w/Threaded Barrel
- Flexible PVC Composition Insulator



NTE Type No.	Kit Contains
72-154-KIT	2 Pair of 72-154 Steel Alligator Clips 2 Pieces of 72-157-0 Black Insulators 2 Pieces of 72-157-2 Red Insulators

NEW

Stainless Steel Alligator Clip w/Barrel, 10 Amp

Features

- Crimp/Solder or Banana Plug Connection
- Overall Length: 1.950" (49.5mm)
- Jaw Opening: .310" (7.87mm)



NTE Type No.	Description
72-156	Stainless Steel Alligator Clip with Barrel

72-156 Series Kit

Features

- 10 Amp Stainless Steel Alligator Clip w/Barrel
- Flexible PVC Composition Insulator



NTE Type No.	Kit Contains
72-156-KIT	2 Pair of 72-156 Stainless Steel Alligator Clips 2 Pieces of 72-157-0 Black Insulators 2 Pieces of 72-157-2 Red Insulators

NEW

Steel Alligator Clip w/U-Shaped Tail, 10 Amp

Features

- Nickel Plated Clip
- Crimp/Solder Connection
- Overall Length: 1.950" (49.5mm)
- Jaw Opening: .310" (7.87mm)



NTE Type No.	Description
72-155	Steel Alligator Clip with U-Shaped Tail

72-155 Series Kit

Features

- 10 Amp Steel Alligator Clip w/U-Shaped Tail
- Flexible PVC Composition Insulator



NTE Type No.	Kit Contains
72-155-KIT	2 Pair of 72-155 Steel Alligator Clips 2 Pieces of 72-157-0 Black Insulators 2 Pieces of 72-157-2 Red Insulators

NEW

PVC Insulator

Features

- Fits 72-148, 72-149, 72-151, 72-153, 72-154, 72-155 & 72-156
- Flexible PVC Composition
- Overall Length: 2.000" (50.8mm)

NTE Type No.	Description
72-157-0	PVC Insulator for 72-148, 72-149, 72-151, 72-153, 72-154, 72-155 & 72-156, Black
72-157-2	PVC Insulator for 72-148, 72-149, 72-151, 72-153, 72-154, 72-155 & 72-156, Red
<i>NEW</i> 72-157-4	PVC Insulator for 72-148, 72-149, 72-151, 72-153, 72-154, 72-155 & 72-156, Yellow
<i>NEW</i> 72-157-5	PVC Insulator for 72-148, 72-149, 72-151, 72-153, 72-154, 72-155 & 72-156, Green
<i>NEW</i> 72-157-6	PVC Insulator for 72-148, 72-149, 72-151, 72-153, 72-154, 72-155 & 72-156, Blue
<i>NEW</i> 72-157-9	PVC Insulator for 72-148, 72-149, 72-151, 72-153, 72-154, 72-155 & 72-156, White



72-148 Series Kits

Features

- 10 Amp Alligator Clip with Barrel
- Flexible PVC Composition Insulator

NTE Type No.	Kit Contains
72-148-KIT1	1 Pair of 72-148 Steel Alligator Clips 1 Pair of 72-157-0 Black Insulators
72-148-KIT2	1 Pair of 72-148 Steel Alligator Clips 1 Pair of 72-157-2 Red Insulators
<i>NEW</i> 72-148-KIT3	1 Pair of 72-148 Steel Alligator Clips 1 Each of 72-157-0 (Black) and 72-157-2 (Red) Insulators



Steel Alligator Clip w/Barrel, Screw & Handle, 10 Amp

Features

- Nickel Plated Clip with Insulated Handle
- Banana Plug or Screw Connection
- Overall Length: 1.950" (49.5mm)
- Jaw Opening: .310" (7.87mm)

NTE Type No.	Description
72-152-0	Steel Alligator Clip with Barrel, Screw and Black Insulated Handle
72-152-2	Steel Alligator Clip with Barrel, Screw and Red Insulated Handle
<i>NEW</i> 72-152-KIT	2 Each of 72-152-0 (Black) & 72-152-2 (Red)

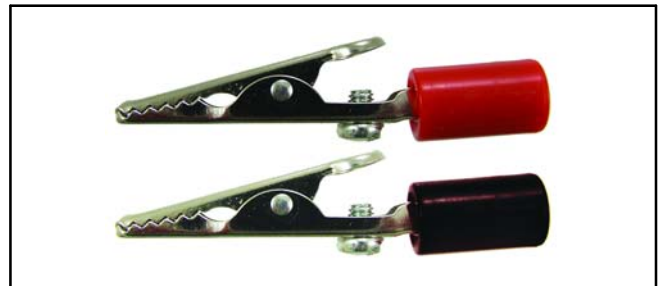

Solid Copper Alligator Clip w/Barrel, Screw & Handle, 10 Amp

Features

- Solid Copper Clip with Insulated Handle
- Banana Plug or Screw Connection
- Overall Length: 1.950" (49.5mm)
- Jaw Opening: .310" (7.87mm)

NTE Type No.	Description
72-150-0	Steel Alligator Clip with Barrel, Screw and Black Insulated Handle
72-150-2	Steel Alligator Clip with Barrel, Screw and Red Insulated Handle
72-150-KIT	2 Each of 72-150-0 (Black) & 72-150-2 (Red)

NEW

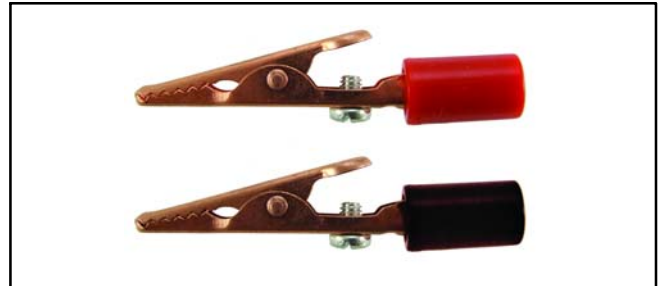

Steel Alligator Clip, Insulated, 10 Amp

Features

- Nickel Plated Clip
- Includes Skin Tight Insulation
- Banana Plug or Screw Connection
- Overall Length: 2.125" (53.9mm)
- Jaw Opening: .310" (7.87mm)

NTE Type No.	Description
72-158-0	Steel Alligator Clip w/Skin Tight Insulation, Black
72-158-2	Steel Alligator Clip w/Skin Tight Insulation, Red
72-158-KIT	2 Each of 72-158-0 (Black) & 72-158-2 (Red)

NEW



Steel Alligator Clip, 5 Amp

Features

- Nickel Plated Clip
- Crimp/Solder Connection
- Overall Length: 1.690" (42.9mm)
- Jaw Opening: .310" (7.87mm)

NTE Type No.	Description
72-159	Steel Alligator Clip



Solid Copper Alligator Clip, 10 Amp

Features

- Crimp/Solder Connection
- Overall Length: 1.690" (42.9mm)
- Jaw Opening: .310" (7.87mm)

NTE Type No.	Description
72-160	Solid Copper Alligator Clip



PVC Insulator

Features

- Fits 72-159 & 72-160
- Skin Tight Insulator Design
- Flexible PVC Composition
- Overall Length: 1.800" (45.7mm)

NTE Type No.	Description
72-161-0	PVC Insulator for 72-159 & 72-160, Black
72-161-2	PVC Insulator for 72-159 & 72-160, Red
NEW 72-161-4	PVC Insulator for 72-159 & 72-160, Yellow
NEW 72-161-5	PVC Insulator for 72-159 & 72-160, Green
NEW 72-161-6	PVC Insulator for 72-159 & 72-160, Blue
NEW 72-161-9	PVC Insulator for 72-159 & 72-160, White



72-159 Series Kits

Features

- 5 Amp Steel Alligator Clip
- Skin Tight Flexible PVC Composition Insulator

NTE Type No.	Kit Contains
72-159-KIT1	1 Pair of 72-159 Steel Alligator Clips 1 Pair of 72-161-0 Black Insulators
72-159-KIT2	1 Pair of 72-159 Steel Alligator Clips 1 Pair of 72-161-2 Red Insulators
NEW 72-159-KIT3	1 Pair of 72-159 Steel Alligator Clips 1 Each of 72-161-0 (Black) and 72-161-2 (Red) Insulators



72-160 Series Kits

Features

- 10 Amp Solid Copper Alligator Clip
- Skin Tight Flexible PVC Composition Insulator

NTE Type No.	Kit Contains
72-160-KIT1	1 Pair of 72-160 Solid Copper Alligator Clips 1 Pair of 72-161-0 Black Insulators
72-160-KIT2	1 Pair of 72-160 Solid Copper Alligator Clips 1 Pair of 72-161-2 Red Insulators
NEW 72-160-KIT3	1 Pair of 72-160 Solid Copper Alligator Clips 1 Each of 72-161-0 (Black) and 72-161-2 (Red) Insulators



Telecom Clip, Bed of Nails & Single Spike Combo

Features

- Nickel-Silver Jaw Material
- Ideal for Telecom Applications
- Crimp or Solder Connection
- Overall Length: 2.600" (66.0mm)
- Jaw Opening: 1.000" (25.4mm)

NTE Type No.	Description
72-167	Insulator-Piercing Alligator Clip, Mitten Style, with Loose Hardware
72-168	Insulator-Piercing Alligator Clip, Mitten Style

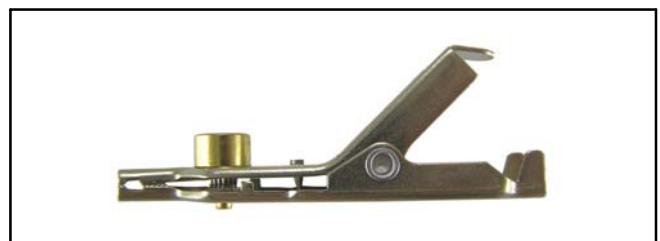

72-168 Series Kit

Features

- Telecom Clip, Bed of Nails & Single Spike Combo
- Skin Tight Flexible PVC Composition Insulator



NTE Type No.	Kit Contains
72-168-KIT	1 Pair of 72-168 Insulation-Piercing Alligator Clips 1 Each of 72-166-0 (Black) and 72-166-2 (Red) Insulators

NEW

Mitten Style PVC Insulator

Features

- Fits 72-167 & 72-168
- Flexible PVC Composition
- Overall Length: 2.600" (66.0mm)



NTE Type No.	Description
72-166-0	PVC Insulator for 72-167 & 72-168, Black
72-166-2	PVC Insulator for 72-167 & 72-168, Red
72-166-4	PVC Insulator for 72-167 & 72-168, Yellow
72-166-5	PVC Insulator for 72-167 & 72-168, Green
72-166-6	PVC Insulator for 72-167 & 72-168, Blue
72-166-9	PVC Insulator for 72-167 & 72-168, White

NEW

NEW

NEW

NEW

Telecom Clip, Bed of Nails & Single Spike Combo

Features

- Nickel-Silver Jaw Material
- Ideal for Telecom Applications
- Crimp or Solder Connection
- Overall Length: 2.600" (66.0mm)
- Jaw Opening: 1.000" (25.4mm)

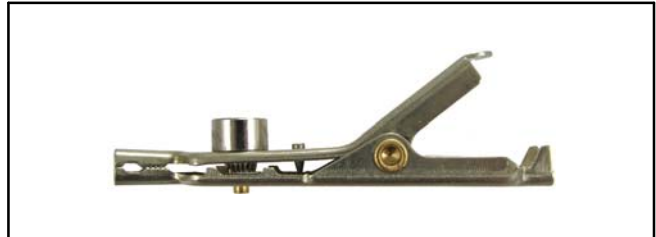

NTE Type No.	Description
72-096	Insulator-Piercing Alligator Clip, Glove Style

Glove Style Insulator for 72-096 Series

Features

- Flexible TPE Composition
- Overall Length: 2.000" (50.8mm)



NTE Type No.	Description
72-099B	TPE Insulator for 72-096 Series Clip, Black
72-099R	TPE Insulator for 72-096 Series Clip, Red

72-096 Series Kit

Features

- Telecom Clip, Bed of Nails & Single Spike Combo
- Skin Tight Flexible PVC Composition Insulator



NTE Type No.	Kit Contains
72-096-KIT	1 Pair of 72-096 Insulation-Piercing Alligator Clips 1 Each of 72-099B (Black) and 72-099R (Red) Insulators

NEW

Steel Alligator Clip, Fang Tooth w/Barrel

Features

- Nickel Plated Clip
- Crimp/Solder or Banana Plug Connection
- Grips Both Fine and Thick Conductors
- Overall Length: 1.920" (48.7mm)
- Jaw Opening: .390" (9.9mm)



NTE Type No.	Description
72-098	Steel Alligator Clip, Fang Tooth with Barrel

Phone Tip Steel Alligator Clip, 10 Amp

Features

- Nickel Plated Clip
- Accepts Standard Phone Tip or Test Probe Tip
- Overall Length: 1.970" (50mm)
- Jaw Opening: .310" (7.9mm)



NTE Type No.	Description
72-181	Phone Tip Steel Alligator Clip

NEW

Heavy Duty Steel Clip, 50 Amp

Features

- Zinc Plated Clip
- Heavy Duty Spring and Construction
- Crimp or Screw Connection
- Overall Length: 4.200" (106.7mm)
- Jaw Opening: 1.100" (27.9mm)

NTE Type No.	Description
72-113	Test Clip
72-113PS	Test Clip with Engraved Plus Sign



NEW

Heavy Duty Solid Copper Clip, 100 Amp

Features

- Heavy Duty Spring and Construction
- Crimp, Screw or Lug Connection
- Overall Length: 4.200" (106.7mm)
- Jaw Opening: 1.100" (27.9mm)

NTE Type No.	Description
72-114	Test Clip
72-114PS	Test Clip with Engraved Plus Sign



NEW

PVC Insulator

Features

- Fits 72-113 & 72-114
- Flexible PVC Composition
- Overall Length: 5.000" (127.0mm)

NTE Type No.	Description
72-115-0	PVC Insulator for 72-113 & 72-114, Black
72-115-2	PVC Insulator for 72-113 & 72-114, Red
72-115-4	PVC Insulator for 72-113 & 72-114, Yellow
72-115-5	PVC Insulator for 72-113 & 72-114, Green
72-115-6	PVC Insulator for 72-113 & 72-114, Blue
72-115-9	PVC Insulator for 72-113 & 72-114, White



NEW

NEW

NEW

NEW

72-113 Series Kits

Features

- Heavy Duty 50 Amp Steel Clip
- Flexible PVC Composition Insulator

NTE Type No.	Kit Contains
72-113-KIT1	1 Pair of 72-113 Heavy Duty Steel Clips 1 Pair of 72-115-0 Black Insulators
72-113-KIT2	1 Pair of 72-113 Heavy Duty Steel Clips 1 Pair of 72-115-2 Red Insulators
72-113-KIT3	1 Pair of 72-113 Heavy Duty Steel Clips 1 Each of 72-115-0 (Black) and 72-115-2 (Red) Insulators



NEW

72-114 Series Kits

Features

- Heavy Duty 100 Amp Solid Copper Clip
- Flexible PVC Composition Insulator

NTE Type No.	Kit Contains
72-114-KIT1	1 Pair of 72-114 Heavy Duty Solid Copper Clips 1 Pair of 72-115-0 Black Insulators
72-114-KIT2	1 Pair of 72-114 Heavy Duty Solid Copper Clips 1 Pair of 72-115-2 Red Insulators
NEW 72-114-KIT3	1 Pair of 72-114 Heavy Duty Solid Copper Clips 1 Each of 72-115-0 (Black) and 72-115-2 (Red) Insulators

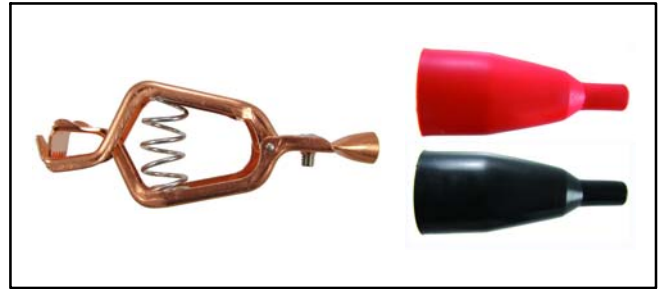

Small Heavy Duty Steel Clip, 25 Amp

Features

- Zinc Plated Clip
- Special Teeth Firmly Grip Round Test Points
- Crimp or Screw Connection
- Overall Length: 2.800" (71.1mm)
- Jaw Opening: .750" (19.0mm)

NTE Type No.	Description
72-116	Test Clip
NEW 72-116PS	Test Clip with Engraved Plus Sign



72-116 Series Kit

Features

- Small Heavy Duty 25 Amp Steel Clip
- Flexible PVC Composition Insulator

NTE Type No.	Kit Contains
NEW 72-116-KIT	1 Pair of 72-116 Small Heavy Duty Clips 1 Each of 72-119-0 (Black) and 72-119-2 (Red) Insulators

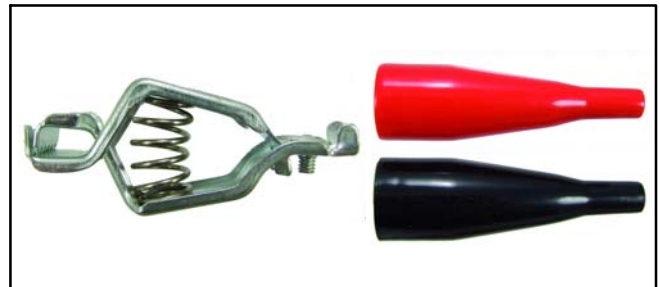

Steel Auto Clip, 40 Amp

Features

- Zinc Plated Clip
- Teeth Mesh Fully on 3 Sides
- Crimp or Screw Connection
- Overall Length: 3.000" (76.2mm)
- Jaw Opening: .750" (19.0mm)

NTE Type No.	Description
72-117	Auto Test Clip



Solid Copper Auto Clip, 75 Amp

Features

- Teeth Mesh Fully on 3 Sides
- Crimp or Screw Connection
- Overall Length: 3.000" (76.2mm)
- Jaw Opening: .750" (19.0mm)

NTE Type No.	Description
72-118	Auto Test Clip



PVC Insulator

Features

- Fits 72-116, 72-117, & 72-118
- Flexible PVC Composition
- Overall Length: 3.800" (96.5mm)

NTE Type No.	Description
72-119-0	PVC Insulator for 72-116, 72-117, & 72-118, Black
72-119-2	PVC Insulator for 72-116, 72-117, & 72-118, Red
<i>NEW</i> 72-119-4	PVC Insulator for 72-116, 72-117, & 72-118, Yellow
<i>NEW</i> 72-119-5	PVC Insulator for 72-116, 72-117, & 72-118, Green
<i>NEW</i> 72-119-6	PVC Insulator for 72-116, 72-117, & 72-118, Blue
<i>NEW</i> 72-119-9	PVC Insulator for 72-116, 72-117, & 72-118, White



72-117 Series Kits

Features

- 40 Amp Steel Auto Clip
- Flexible PVC Composition Insulator

NTE Type No.	Kit Contains
72-117-KIT1	1 Pair of 72-117 Steel Auto Clips 1 Pair of 72-119-0 Black Insulators
72-117-KIT2	1 Pair of 72-117 Steel AutoClips 1 Pair of 72-119-2 Red Insulators
<i>NEW</i> 72-117-KIT3	1 Pair of 72-117 Steel Auto Clips 1 Each of 72-119-0 (Black) and 72-119-2 (Red) Insulators

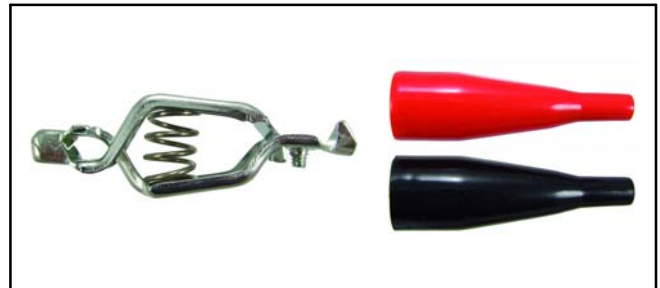

72-118 Series Kits

Features

- 75 Amp Solid Copper Auto Clip
- Flexible PVC Composition Insulator

NTE Type No.	Kit Contains
72-118-KIT1	1 Pair of 72-118 Solid Copper Auto Clips 1 Pair of 72-119-0 Black Insulators
72-118-KIT2	1 Pair of 72-118 Solid Copper AutoClips 1 Pair of 72-119-2 Red Insulators
<i>NEW</i> 72-118-KIT3	1 Pair of 72-118 Solid Copper Auto Clips 1 Each of 72-119-0 (Black) and 72-119-2 (Red) Insulators

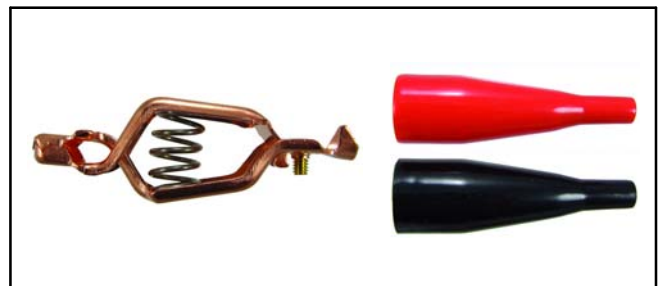

General Purpose Steel Test Clip, 20 Amp

Features

- Zinc Plated Clip
- Crimp or Screw Connection
- Overall Length: 2.400" (60.9mm)
- Jaw Opening: .630" (16.0mm)

NTE Type No.	Description
72-120	General Purpose Test Clip



General Purpose Solid Copper Test Clip, 40 Amp

Features

- Crimp or Screw Connection
- Overall Length: 2.400" (60.9mm)
- Jaw Opening: .630" (16.0mm)

NTE Type No.	Description
72-121	General Purpose Solid Copper Test Clip



PVC Insulator

Features

- Fits 72-120 & 72-121
- Flexible PVC Composition
- Overall Length: 3.500" (88.9mm)

NTE Type No.	Description
72-122-0	PVC Insulator for 72-120 & 72-121, Black
72-122-2	PVC Insulator for 72-120 & 72-121, Red
<i>NEW</i> 72-122-4	PVC Insulator for 72-120 & 72-121, Yellow
<i>NEW</i> 72-122-5	PVC Insulator for 72-120 & 72-121, Green
<i>NEW</i> 72-122-6	PVC Insulator for 72-120 & 72-121, Blue
<i>NEW</i> 72-122-9	PVC Insulator for 72-120 & 72-121, White



72-120 Series Kits

Features

- 20 Amp Steel General Purpose Clip
- Flexible PVC Composition Insulator

NTE Type No.	Kit Contains
72-120-KIT1	1 Pair of 72-120 Gen Purp Steel Clips 1 Pair of 72-122-0 Black Insulators
72-120-KIT2	1 Pair of 72-120 Gen Purp Steel Clips 1 Pair of 72-122-2 Red Insulators
<i>NEW</i> 72-120-KIT3	1 Pair of 72-120 Gen Purp Steel Clips 1 Each of 72-122-0 (Black) and 72-122-2 (Red) Insulators



72-121 Series Kits

Features

- 40 Amp Solid Copper General Purpose Clip
- Flexible PVC Composition Insulator

NTE Type No.	Kit Contains
72-121-KIT1	1 Pair of 72-121 Gen Purp Solid Copper Clips 1 Pair of 72-122-0 Black Insulators
72-121-KIT2	1 Pair of 72-121 Gen Purp Solid Copper Clips 1 Pair of 72-122-2 Red Insulators
<i>NEW</i> 72-121-KIT3	1 Pair of 72-121 Gen Purp Solid Copper Clips 1 Each of 72-122-0 (Black) and 72-122-2 (Red) Insulators



Petite Steel Clip, 5 Amp

Features

- Zinc Plated Clip
- Teeth Mesh Fully for General Testing
- Crimp or Screw Connection
- Overall Length: 1.550" (39.4mm)
- Jaw Opening: .320" (8.1mm)

NTE Type No.	Description
72-136	Petite Steel Clip



72-136 Series Kit

Features

- 5 Amp Petite Steel Clip
- Flexible PVC Composition Insulator

NTE Type No.	Kit Contains
<i>NEW</i> 72-136-KIT	2 Pair of 72-136 Petite Steel Clips 2 Each of 72-143-0 (Black) and 72-143-2 (Red) Insulators



Petite Solid Copper Clip, 10 Amp

Features

- Teeth Mesh Fully for General Testing
- Crimp or Screw Connection
- Overall Length: 1.550" (39.4mm)
- Jaw Opening: .320" (8.1mm)

NTE Type No.	Description
72-137	Petite Solid Copper Clip



72-137 Series Kit

Features

- 10 Amp Petite Solid Copper Clip
- Flexible PVC Composition Insulator

NEW

NTE Type No.	Kit Contains
72-137-KIT	2 Pair of 72-137 Petite Solid Copper Clips 2 Each of 72-143-0 (Black) and 72-143-2 (Red) Insulators

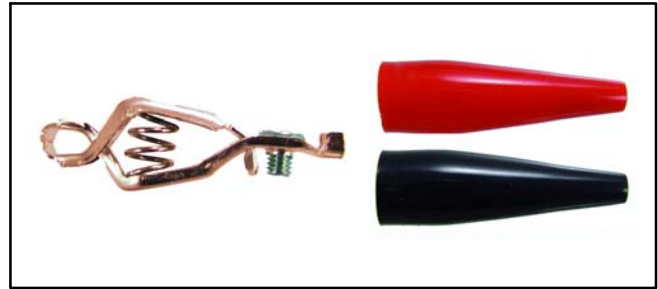

PVC Insulator

Features

- Fits 72-136 & 72-137
- Flexible PVC Composition
- Overall Length: 2.000" (50.8mm)

NEW

NEW

NEW

NEW

NTE Type No.	Description
72-143-0	PVC Insulator for 72-136 & 72-137, Black
72-143-2	PVC Insulator for 72-136 & 72-137, Red
72-143-4	PVC Insulator for 72-136 & 72-137, Yellow
72-143-5	PVC Insulator for 72-136 & 72-137, Green
72-143-6	PVC Insulator for 72-136 & 72-137, Blue
72-143-9	PVC Insulator for 72-136 & 72-137, White



Analyzer Clip, Steel, 10 Amp

Features

- Zinc Plated Steel
- Teeth Mesh Fully on 3 Sides
- Crimp or Screw Connection
- Overall Length: 2.000" (50.8mm)
- Jaw Opening: .500" (12.7mm)

NTE Type No.	Description
72-144	Steel Analyzer Clip



72-144 Series Kit

Features

- 10 Amp Steel Analyzer Clip
- Flexible PVC Composition Insulator

NEW

NTE Type No.	Kit Contains
72-144-KIT	1 Pair of 72-144 Steel Analyzer Clips 1 Each of 72-146-0 (Black) and 72-146-2 (Red) Insulators



Analyzer Clip, Solid Copper, 20 Amp

Features

- Teeth Mesh Fully on 3 Sides
- Crimp or Screw Connection
- Overall Length: 2.000" (50.8mm)
- Jaw Opening: .500" (12.7mm)

NTE Type No.	Description
72-145	Solid Copper Analyzer Clip

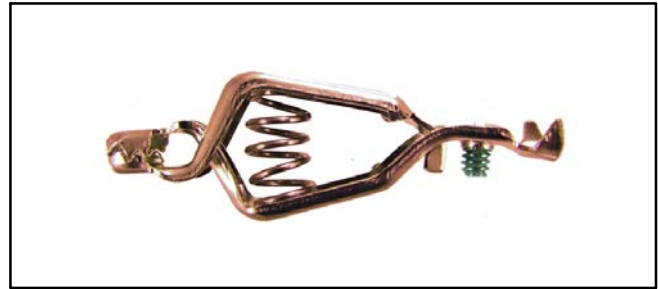

72-145 Series Kit

Features

- 20 Amp Solid Copper Analyzer Clip
- Flexible PVC Composition Insulator

NTE Type No.	Kit Contains
NEW 72-145-KIT	1 Pair of 72-145 Solid Copper Analyzer Clips 1 Each of 72-146-0 (Black) and 72-146-2 (Red) Insulators



PVC Insulator

Features

- Fits 72-144 & 72-145
- Flexible PVC Composition
- Overall Length: 2.560" (65.0mm)

NTE Type No.	Description
72-146-0	PVC Insulator for 72-144 & 72-145, Black
72-146-2	PVC Insulator for 72-144 & 72-145, Red
NEW 72-146-4	PVC Insulator for 72-144 & 72-145, Yellow
NEW 72-146-5	PVC Insulator for 72-144 & 72-145, Green
NEW 72-146-6	PVC Insulator for 72-144 & 72-145, Blue
NEW 72-146-9	PVC Insulator for 72-144 & 72-145, White



Croc Clip, Steel, 5 Amp

Features

- Zinc Plated Clip
- Long Serrated Nose for Solid Contact
- Crimp or Screw Connection
- Overall Length: 2.125" (53.9mm)
- Jaw Opening: .320" (8.1mm)

NTE Type No.	Description
72-163	Steel Croc Clip



Croc Clip, Solid Copper, 10 Amp

Features

- Long Serrated Nose for Solid Contact
- Crimp or Screw Connection
- Overall Length: 2.125" (53.9mm)
- Jaw Opening: .320" (8.1mm)

NTE Type No.	Description
72-164	Solid Copper Croc Clip



PVC Insulator

Features

- Fits 72-163 & 72-164
- Flexible PVC Composition
- Overall Length: 1.700" (43.1mm)

NTE Type No.	Description
72-165-0	PVC Insulator for 72-163 & 72-164, Black
72-165-2	PVC Insulator for 72-163 & 72-164, Red
<i>NEW</i> 72-165-4	PVC Insulator for 72-163 & 72-164, Yellow
<i>NEW</i> 72-165-5	PVC Insulator for 72-163 & 72-164, Green
<i>NEW</i> 72-165-6	PVC Insulator for 72-163 & 72-164, Blue
<i>NEW</i> 72-165-9	PVC Insulator for 72-163 & 72-164, White



72-163 Series Kits

Features

- 5 Amp Steel Croc Clip
- Flexible PVC Composition Insulator

NTE Type No.	Kit Contains
72-163-KIT	2 Pair of 72-163 Steel Croc Clips 2 Each of 72-165-0 (Black) and 72-165-2 (Red) Insulators
72-163-KIT1	1 Pair of 72-163 Steel Croc Clips 1 Pair of 72-165-0 Black Insulators
72-163-KIT2	1 Pair of 72-163 Steel Croc Clips 1 Pair of 72-165-2 Red Insulators
<i>NEW</i> 72-163-KIT3	1 Pair of 72-163 Steel Croc Clips 1 Each of 72-165-0 (Black) and 72-165-2 (Red) Insulators



72-164 Series Kits

Features

- 10 Amp Solid Copper Croc Clip
- Flexible PVC Composition Insulator

NTE Type No.	Kit Contains
72-164-KIT1	1 Pair of 72-164 Solid Copper Croc Clips 1 Pair of 72-165-0 Black Insulators
72-164-KIT2	1 Pair of 72-164 Solid Copper Croc Clips 1 Pair of 72-164-2 Red Insulators
<i>NEW</i> 72-164-KIT3	1 Pair of 72-164 Solid Copper Croc Clips 1 Each of 72-165-0 (Black) and 72-165-2 (Red) Insulators

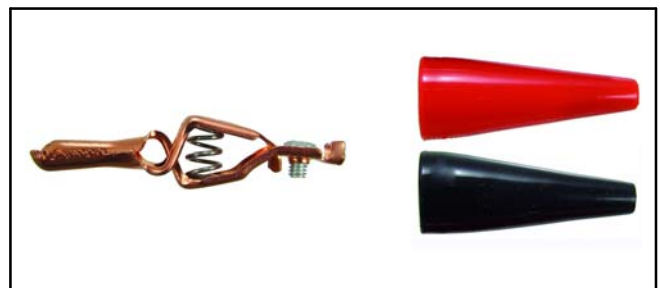

Heavy Duty Solid Copper Clip, 200 Amp

Features

- Heavy Duty Spring and Construction
- Lug Connection
- Overall Length: 6.000" (152.4mm)
- Jaw Opening: 1.625" (41.3mm)



NTE Type No.	Description
72-173	Test Clip
72-173PS	Test Clip with Engraved Plus Sign

NEW

NEW

Heavy Duty Zinc Plated Steel Clip, 100 Amp

Features

- Heavy Duty Spring and Construction
- Lug Connection
- Overall Length: 6.000" (152.4mm)
- Jaw Opening: 1.625" (41.3mm)



NTE Type No.	Description
72-174	Test Clip
72-174PS	Test Clip with Engraved Plus Sign

NEW

NEW

PVC Insulator

Features

- Fits 72-173, 72-173PS, 72-174 & 72-174PS
- Flexible PVC Composition
- Overall Length: 6.811" (173mm)



NTE Type No.	Description
72-176-0	PVC Insulator for 72-173, 72-173PS, 72-174 & 72-174PS, Black
72-176-2	PVC Insulator for 72-173, 72-173PS, 72-174 & 72-174PS, Red
72-176-4	PVC Insulator for 72-173, 72-173PS, 72-174 & 72-174PS, Yellow
72-176-5	PVC Insulator for 72-173, 72-173PS, 72-174 & 72-174PS, Green
72-176-6	PVC Insulator for 72-173, 72-173PS, 72-174 & 72-174PS, Blue
72-176-9	PVC Insulator for 72-173, 72-173PS, 72-174 & 72-174PS, White

NEW

NEW

NEW

NEW

NEW

NEW

Fully Insulated Heavy Duty Clamp, 500 Amp

Features

- High Impact, Glass-Filled Nylon Jaws
- Braided Copper Shunt
- Replaceable Copper Contact Pads
- Nut & Bolt or Crimp/Solder Lug Connection
- Overall Length: 6.500" (165.1mm)
- Jaw Opening: 1.700" (43.2mm)

NTE Type No.	Description
72-112-0	Fully Insulated Heavy Duty Clamp, Black
72-112-2	Fully Insulated Heavy Duty Clamp, Red



Petite Plier-Type Steel Clip, 15 Amp

Features

- Nickel Plated
- Crimp or Solder Connection
- Includes PVC Sleeve Insulators
- Overall Length: 2.300" (58.4mm)
- Jaw Opening: .750" (19.05mm)

NTE Type No.	Description
72-132-0	Petite Plier-Type Steel Clip with Black Insulators
72-132-2	Petite Plier-Type Steel Clip with Red Insulators
72-132-KIT	Contains 1 ea. of 72-132-0 (Black) & 72-132-2 (Red)



NEW

Plier-Type Copper Plated Steel Clip, 200 Amp

Features

- Copper Plated Clip
- Heavy Duty Spring and Construction
- Perfect for Battery Terminals or Grounding Applications
- Crimp or Solder Connection
- Overall Length: 6.000" (152.4mm)
- Jaw Opening: 1.600" (40.6mm)

NTE Type No.	Description
72-133	Plier-Type Copper Plated Steel Clip
72-133-0	1 Piece 72-133 with Black (72-135-0) Insulators
72-133-2	1 Piece 72-133 with Red (72-135-2) Insulators



NEW

NEW

Plier-Type Solid Copper Clip, 400 Amp

Features

- Heavy Duty Spring and Construction
- Perfect for Battery Terminals or Grounding Applications
- Crimp or Solder Connection
- Overall Length: 6.000" (152.4mm)
- Jaw Opening: 1.600" (40.6mm)

NTE Type No.	Description
72-134	Plier-Type Solid Copper Clip
72-134-0	1 Piece 72-134 with Black (72-135-0) Insulators
72-134-2	1 Piece 72-134 with Red (72-135-2) Insulators



NEW

NEW

PVC Insulator

Features

- Fits 72-133 & 72-134
- 2 Required per Clip
- Flexible PVC Composition
- Overall Length: 4.500" (114.3mm)

NTE Type No.	Description
72-135-0	PVC Insulator for 72-133 & 72-134, Black
72-135-2	PVC Insulator for 72-133 & 72-134, Red



Mini Plier-Type Copper Plated Steel Clip, 50 Amp

Features

- Copper Plated Clip
- Perfect for Chargers or Battery Terminals
- Crimp or Solder Connection
- Overall Length: 2.900" (73.6mm)
- Jaw Opening: 1.125" (28.6mm)

NTE Type No.	Description
72-139	Miniature Plier-Type Copper Plated Steel Clip
72-138-0	1 Piece 72-139 with Black (72-142-0) Insulators
72-138-2	1 Piece 72-139 with Red (72-142-2) Insulators
72-138-KIT	1 Each of 72-138-0 (Black) and 72-138-2 (Red)
72-139-KIT	1 Pair of 72-139 Mini Plier-Type Copper Plated Steel Clip 2 Each of 72-142-0 (Black) and 72-142-2 (Red) Insulators



NEW

NEW

NEW

NEW

Mini Plier-Type Zinc Plated Steel Clip, 50 Amp

Features

- Zinc Plated Clip
- Perfect for Chargers or Battery Terminals
- Crimp or Solder Connection
- Overall Length: 2.900" (73.6mm)
- Jaw Opening: 1.125" (28.6mm)

NTE Type No.	Description
72-140	Miniature Plier-Type Zinc Plated Steel Clip
72-140-KIT	1 Pair of 72-140 Mini Plier-Type Zinc Plated Steel Clip 2 Each of 72-142-0 (Black) and 72-142-2 (Red) Insulators



NEW

Mini Plier-Type Solid Copper Clip, 75 Amp

Features

- Perfect for Chargers or Battery Terminals
- Crimp or Solder Connection
- Overall Length: 2.900" (73.6mm)
- Jaw Opening: 1.125" (28.6mm)

NTE Type No.	Description
72-141	Miniature Plier-Type Solid Copper Clip
72-141-KIT	1 Pair of 72-141 Mini Plier-Type Solid Copper Clip 2 Each of 72-142-0 (Black) and 72-142-2 (Red) Insulators



NEW

PVC Insulator

Features

- Fits 72-139, 72-140 & 72-141
- 2 Required per Clip
- Flexible PVC Composition
- Overall Length: 1.600" (40.64mm)

NTE Type No.	Description
72-142-0	PVC Insulator for 72-139, 72-140 & 72-141, Black
72-142-2	PVC Insulator for 72-139, 72-140 & 72-141, Red



Fully Insulated Small Charger Clip

Features

- Kelvin Capable
- Perfect for Charging or Grounding Applications
- Crimp or Solder Connection
- Overall Length: 4.100" (104.1mm)
- Jaw Opening: 1.250" (31.7mm)

NTE Type No.	Description
72-094	Plier-Type Fully Insulated Charger Clip, Black
72-095	Plier-Type Fully Insulated Charger Clip, Red



Kelvin Clip, Insulated, 10 Amp

Features

- Clip Halves are Electrically Isolated
- Gold Contacts
- Screw Connection
- Overall Length: 1.600" (40.6mm)
- Jaw Opening: .310" (7.87mm)

NTE Type No.	Description
72-162	Kelvin Clip, Insulated

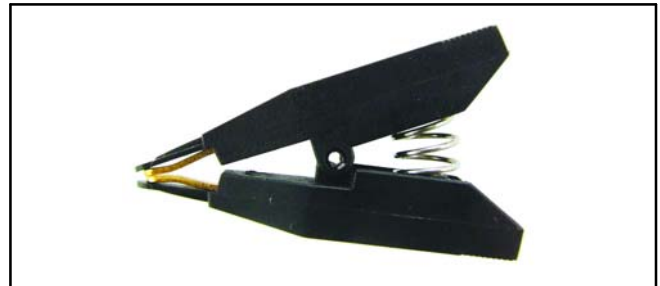

Apprentice / OEM Style Test Lead Set

Features

- UL/CSA Compliant
- Compatible with All Industry Standard 4mm Instrument (DMM) Sockets
- Modular Test Leads Allow the User to Choose the Appropriate Accessory for Application

NTE Type No.	Set Contains
72-065	1 Pair 48" (1.2m) Modular, Double Insulated Silicone Lead Assemblies 1 Pair Extra Sharp, Stainless Steel Probes 1 Pair Fully Insulated Crocodile Clips 1 Pair Probe Tip Insulation Extenders



Specifications

IEC 1010 Rating: 1000V CAT3 / 600V CAT4 □ 20 Amps

Test Lead Set

Features

- UL/CSA Compliant
- Compatible with All Industry Standard 4mm Instrument Sockets
- 48" (1.2m) Double Insulated, Bi-Color Silicone Cable Boasts 250+ Copper Strands for Maximum Flexibility and Overall Performance
- Bi-Color Insulation Design Alerts User if Exposed Conductor Shock Hazard is Imminent

NTE Type No.	Termination
72-066	OEM Fixed Shroud to Fixed Shroud
72-067	OEM Fixed Shroud to Right Angle

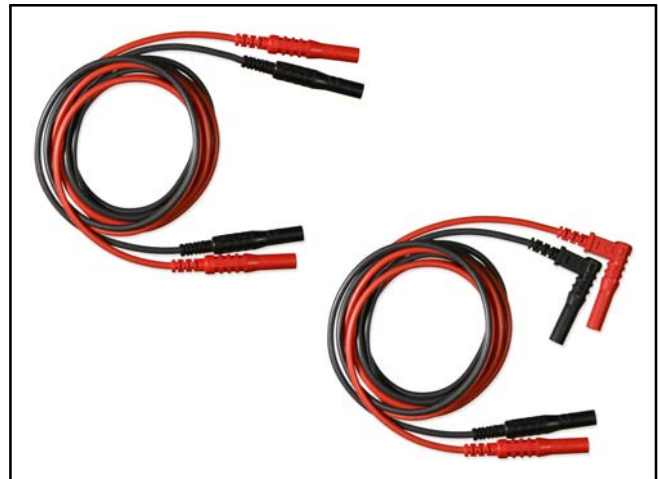

Specifications

IEC 1010 Rating: 1000V CAT3 / 600V CAT4 □ 20 Amps

8-32 UNC Threaded Probe Test Lead Set

Features

- Compatible with All Industry Standard 4mm Instrument Sockets
- 48" (1.2m) Double Insulated, Bi-Color Silicone Cable Boasts 250+ Copper Strands for Maximum Flexibility and Overall Performance
- Bi-Color Insulation Design Alerts User if Exposed Conductor Shock Hazard is Imminent
- Industry Standard 8-32-UNC-2A Threaded Probe Tip Accepts Screw-On Accessories
- Extremely Sharp Stainless Steel Probe Tip

NTE Type No.	Termination
72-068	Right Angle Plug



Specifications

IEC 1010 Rating: 1000V CAT3 □ 20 Amps

Temperature Rating: -10° to +150°C

Standard Test Lead Probe Set

Features

- Compatible with All Industry Standard 4mm Instrument Sockets
- 48" (1.2m) Double Insulated, Bi-Color Silicone Cable Boasts 250+ Copper Strands for Maximum Flexibility and Overall Performance
- Bi-Color Insulation Design Alerts User if Exposed Conductor Shock Hazard is Imminent
- Industry Standard 8-32-UNC-2A Threaded Probe Tip Accepts Screw-On Accessories
- Extremely Sharp Stainless Steel Probe Tip

NTE Type No.	Set Contains
72-097	1 Pair (Red & Black) of Double Insulated Silicone Lead Assemblies with Right Angle Plug 1 Pair (Red & Black) Fully Insulated Screw-On Crocodile Clips (Note 1)

Note 1. This item rated 300V CAT2 10 Amps



Specifications

IEC 1010 Rating: 1000V CAT3 \square 20 Amps

Temperature Rating: -10° to +150°C

Test Lead Set

Features

- Compatible with All Industry Standard 4mm Instrument Sockets
- 48" (1.2m) Double Insulated, Bi-Color Silicone Cable Boasts 250+ Copper Strands for Maximum Flexibility and Overall Performance
- Bi-Color Insulation Design Alerts User if Exposed Conductor Shock Hazard is Imminent

NTE Type No.	Set Contains
72-077	1 Pair (Red & Black) of Double Insulated Silicone Lead Assemblies 1 Pair (Red & Black) Test Probes 1 Pair (Red & Black) Sprung Hooks 1 Pair (Red & Black) of Large, Fully Insulated Crocodile Clips



Specifications

IEC 1010 Rating: 1000V CAT3 \square 20 Amps

Lantern Fronted Test Lead Set

Features

- Compatible with All Industry Standard 4mm Instrument Sockets
- 48" (1.2m) Double Insulated, Bi-Color Silicone Cable Boasts 250+ Copper Strands for Maximum Flexibility and Overall Performance
- Bi-Color Insulation Design Alerts User if Exposed Conductor Shock Hazard is Imminent
- Industry Standard 4mm Lantern Tip Accepts Push-On Accessories

NTE Type No.	Termination
72-070	Right Angle Plug
72-071	Shutter Plug

Specifications

IEC 1010 Rating: 1000V CAT3 \square 20 Amps

Temperature Rating: -10° to +150°C

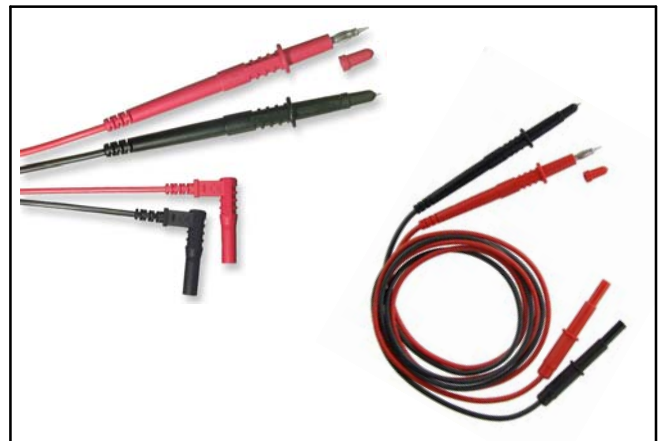

Lantern Fronted Test Lead Set

Features

- Compatible with All Industry Standard 4mm Instrument Sockets
- 48" (1.2m) Double Insulated, Bi-Color Silicone Cable Boasts 250+ Copper Strands for Maximum Flexibility and Overall Performance
- Bi-Color Insulation Design Alerts User if Exposed Conductor Shock Hazard is Imminent
- Industry Standard 4mm Lantern Tip Accepts Push-On Accessories

NTE Type No.	Set Contains
72-090	1 Pair (Red & Black) of 48" (1.2m) Double Insulated Silicone Leads. Each lead is terminated by a 4mm Lantern Probe Tip on one end, the other end is terminated in a Right Angle Plug 1 Pair (Red & Black) of 1kV large Crocodile Clips



Specifications

IEC 1010 Rating: 1000V CAT3 □ 20 Amps

Temperature Rating: -10° to +150°C

OEM Fixed Tip Fused Probe Set

Features

- UL/CSA Compliant
- 48" (1.2m) Double Insulated, Bi-Color Silicone Cable Boasts 250+ Copper Strands for Maximum Flexibility and Overall Performance
- Compatible with All Industry Standard 4mm Instrument Sockets

NTE Type No.	Set Contains
72-078	1 Pair (Red & Black) of Double Insulated Silicone Lead Assemblies with Right Angle Plug

Specifications

IEC 1010 Rating: 1000V CAT3 / 600V CAT4 □

Temperature Rating: -10° to +150°C

Fuse Rating: 500mA/1000V 50kA

Accessories

Replacement Fuse: 72-002

Compatible Crocodile Clips: 72-059 (Black), 72-060 (Red)



Multi-Stacking Safety Patch Cords

Features

- Compatible with All Industry Standard 4mm Banana Plugs and Sockets
- 48" (1.2m) Double Insulated, Bi-Color Silicone Cable Boasts 250+ Copper Strands for Maximum Flexibility and Overall Performance

NTE Type No.	Description
72-093	1 Pair (Red & Black) of Double Insulated Silicone Lead Assemblies with Stackable Plug

Specifications

IEC 1010 Rating: 1000V CAT3 / 600V CAT4 □ 20 Amps



Universal Kelvin Test Lead Set

Features

- Gold-Plated Kelvin Crocodile Clips Allow 4-Wire Resistive Measurements
- 48" (1.2m) Double Insulated, Bi-Color Silicone Cable Boasts 250+ Copper Strands for Maximum Flexibility and Overall Performance
- Compatible with All Industry Standard 4mm Instrument Sockets and Spade-Accommodating Binding Posts

NTE Type No.	Kit Contains
72-076	1 Pair (Red/Grey & Black/Grey) of 48" (1.2m) Kelvin Crocodile Clip Leads using low loss 1mm ² multistranded double skin silicone cables terminating in 4mm Shutter Plugs color coded to each relevant Jaw. 2 Pairs (2 Red & 2 Black) of Full Safety Spade Adapters.

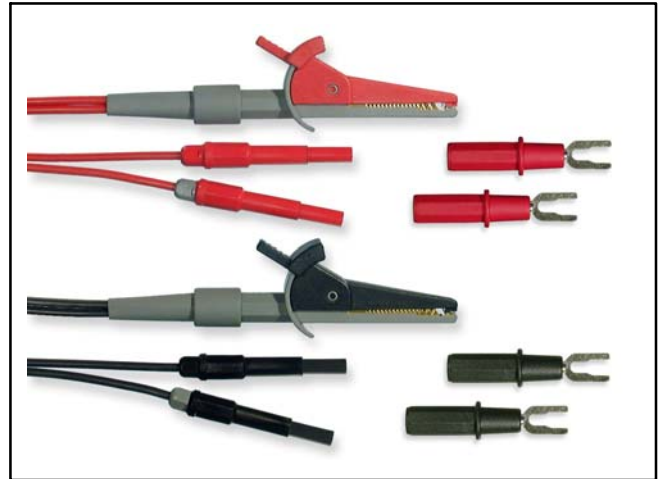

OEM Fixed Lead Probe Test Lead Set

Features

- UL/CSA Compliant
- 48" (1.2m) Double Insulated, Bi-Color Silicone Cable Boasts 250+ Copper Strands for Maximum Flexibility and Overall Performance
- 8-32-UNC-2A Threaded Notched Needle Tip Accepts Screw-On Accessories
- Compatible with "Simpson" Style Instruments

NTE Type No.	Sett Contains
<i>NEW</i> 72-175	1 Pair (Red & Black) of Double Insulated Silicone Lead Assemblies with Right Angle Sockets



Specifications

IEC 1010 Rating: 1000V CAT3
 Temperature Rating: -10° to +150°C

Crocodile Clip, Flanged, Fully Insulated

Features

- UL/CSA Compliant
- Accepts All Standard 4mm Test Lead Plugs
- Offset Jaw & Special Tooth Design Grips Small an Large Diameter Test Points Securely



TL-010

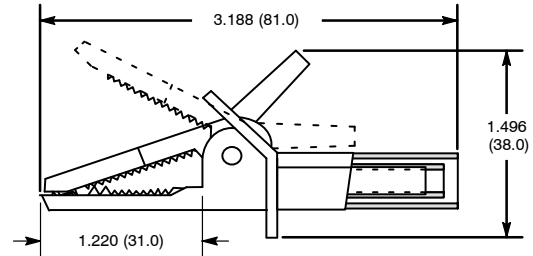

NTE Type No.	Color	Diag No.
72-053	Black	TL-010
72-054	Red	TL-010
72-054-KIT	Contains 1 ea. of 72-053 & 72-054	

Specifications

IEC 1010 Rating: 1000V CAT2 / 600V CAT3 20 Amps
 Maximum Jaw Opening: .945" (24mm)

NEW

Crocodile Clip, Small, Fully Insulated

Features

- Accepts All Standard 4mm Test Lead Plugs
- Small Size is Ideal for Connecting to Confined Test Points



TL-011

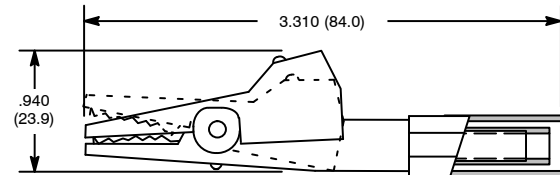

NTE Type No.	Color	Diag No.
72-055	Black	TL-011
72-056	Red	TL-011
72-056-KIT	Contains 1 ea. of 72-055 & 72-056	

Specifications

Rating: 1000V CAT2, 20 Amps
 Maximum Jaw Opening: .275" (7mm)

NEW

Crocodile Clip, Large, Fully Insulated

Features

- UL/CSA Compliant
- Accepts All Standard 4mm Test Lead Plugs
- Wide Jaw Opening & Special Tooth Design Assures Firm Grip and Electrical Contact



TL-012

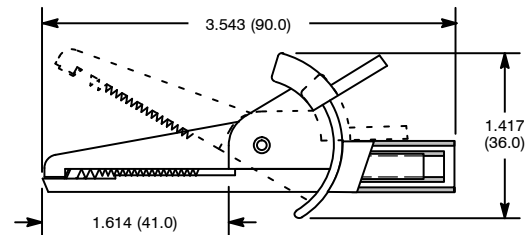

NTE Type No.	Color	Diag No.
72-057	Black	TL-012
72-058	Red	TL-012
72-058-KIT	Contains 1 ea. of 72-057 & 72-058	

Specifications

IEC 1010 Rating: 1000V CAT3 / 600V CAT4 30 Amps
 Maximum Jaw Opening: .866" (22mm)

NEW

Crocodile Clip, Screw Type

Features

- UL/CSA Compliant
- For Use With 1000V Fused Probe Bodies



TL-013

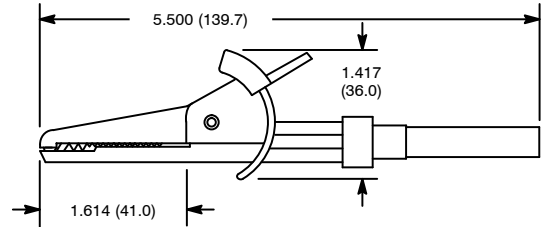

NTE Type No.	Color	Diag No.
72-059	Black	TL-013
72-060	Red	TL-013
72-060-KIT	Contains 1 ea. of 72-059 & 72-060	

NEW

Specifications

IEC 1010 Rating: 1000V CAT3
 Maximum Jaw Opening: .866" (22mm)

Standard Probe, 4mm

Features

- Accepts All Industry Standard 4mm Test Lead Plugs
- Socket to Rear



NTE Type No.	Color	Diag No.
72-012	Black	TL-002
72-013	Red	TL-002
72-013-KIT	Contains 1 ea. of 72-012 & 72-013	

TL-002

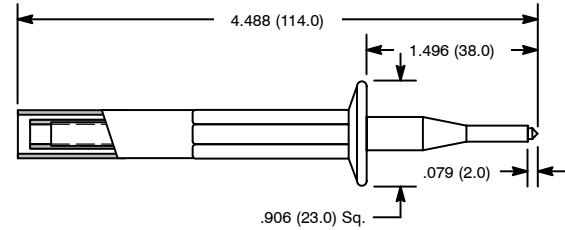

Specifications

IEC 1010 Rating: 1000V CAT3 □ 30 Amps

NEW

OEM Style Probe, 4mm

Features

- Accepts All Industry Standard 4mm Test Lead Plugs
- Extremely Sharp, Stainless Steel Point
- Socket to Rear



NTE Type No.	Color	Diag No.
72-049	Black	TL-003
72-050	Red	TL-003
72-050-KIT	Contains 1 ea. of 72-049 & 72-050	

TL-003

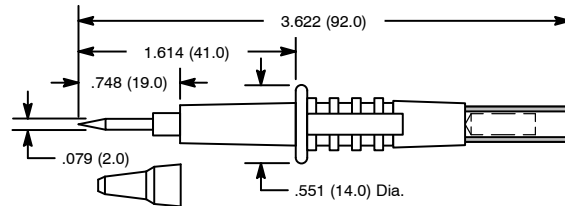

Specifications

IEC 1010 Rating: 1000V CAT3 / 600V CAT4 □ 30 Amps

NEW

Long Reach Probe, 4mm

Features

- Accepts All Industry Standard 4mm Test Lead Plugs
- Socket to Rear



NTE Type No.	Color	DiagNo.
72-014	Black	TL-004
72-015	Red	TL-004
72-015-KIT	Contains 1 ea. of 72-012 & 72-013	

TL-004

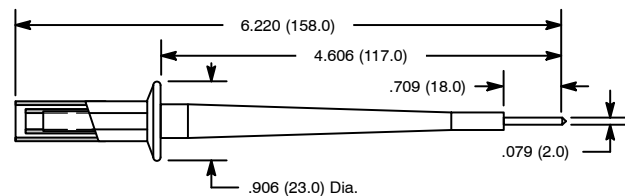

Specifications

IEC 1010 Rating: 1000V CAT3 □ 20 Amps

NEW

Thin Spike Probe, 4mm

Features

- Accepts All Industry Standard 4mm Test Lead Plugs
- Designed for Precise Probing



NTE Type No.	Color	Diag No.
72-020	Black	TL-005
72-021	Red	TL-005
72-021-KIT	Contains 1 ea. of 72-020 & 72-021	

TL-005

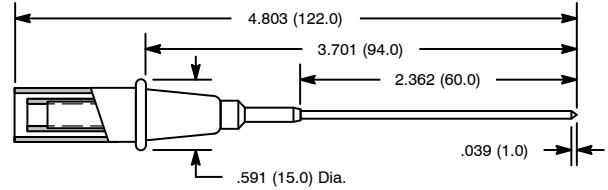

Specifications

IEC 1010 Rating: 1000V CAT3 / 600V CAT4 □ 10 Amps

NEW

Long Tip Probe, 4mm

Features

- Accepts All Industry Standard 4mm Test Lead Plugs
- 2mm Dia. Probe to Front
- Socket to Rear



NTE Type No.	Color	Diag No.
72-010	Black	TL-006
72-011	Red	TL-006
72-011-KIT	Contains 1 ea. of 72-010 & 72-011	

TL-006

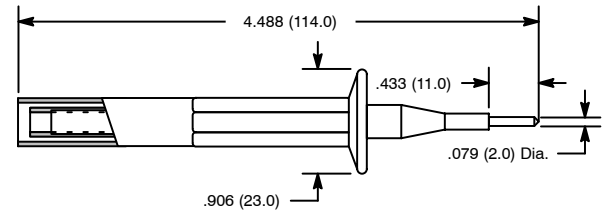

Specifications

IEC 1010 Rating: 1000V CAT3 □ 30 Amps

NEW

Lantern Probe, 4mm

Features

- Accepts All Industry Standard 4mm Test Lead Plugs
- Lantern Probe Tip
- Socket to Rear



NTE Type No.	Color	Diag No.
72-018	Black	TL-007
72-019	Red	TL-007
72-019-KIT	Contains 1 ea. of 72-018 & 72-019	

TL-007

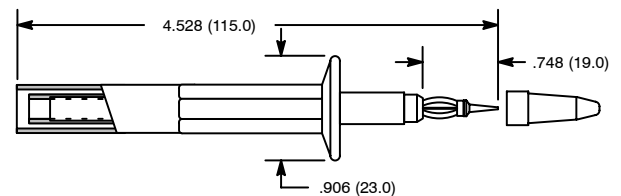

Specifications

IEC 1010 Rating: 1000V CAT3 □ 30 Amps

NEW

Fused Modular Probe, 4mm

Features

- Accepts All Industry Standard 4mm Test Lead Plugs
- Fused Probe Protects User From Shock, Even if the Instrument is Fused
- Fuse is Easily Serviced Without the Use of Tools



NTE Type No.	Color	Replacement Fuse	Diag No.
72-022	Black	72-002	TL-008
72-023	Red	72-002	TL-008
72-023-KIT	Contains 1 ea. of 72-022 & 72-023		

TL-008

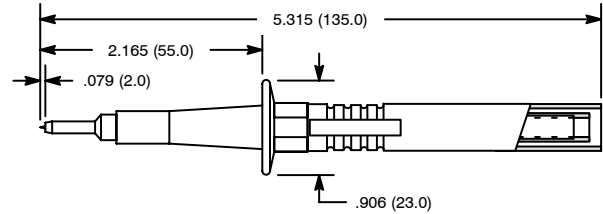

Specifications

IEC 1010 Rating: 1000V CAT3 / 600V CAT4 □ 0.5 Amps
 Fuse Rating: 500mA/1000V/50kA

North American Line Power Receptacle Test Adaptor

Features

- UL/CSA Compliant
- Accepts All Industry Standard 4mm Test Lead Plugs
- Bladed Probes Assure Sound Electrical Contact with Standard A/C Receptacles



NTE Type No.	Color	Diag No.
72-024	Black	TL-016
72-025	Red	TL-016
72-025-KIT	Contains 1 ea. of 72-024 & 72-025	

TL-016

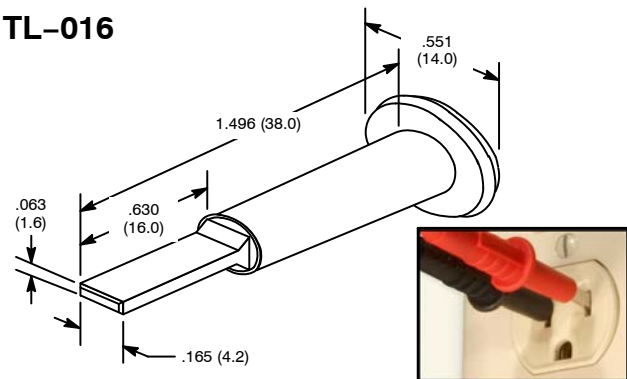

Specifications

IEC 1010 Rating: 1000V CAT3 / 600V CAT4 □ 30 Amps

Sprung Hook, 4mm

Features

- Accepts All Industry Standard 4mm Test Lead Plugs
- Ideal for Hands-Free Connection to IC Legs and Small Conductors

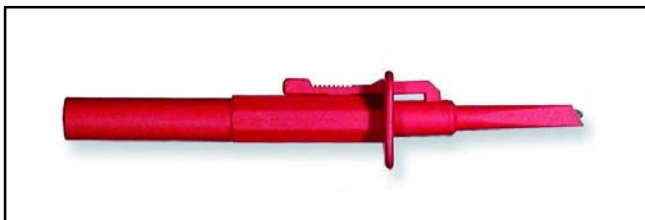

NTE Type No.	Color	Diag No.
72-017	Red	TL-009

TL-009

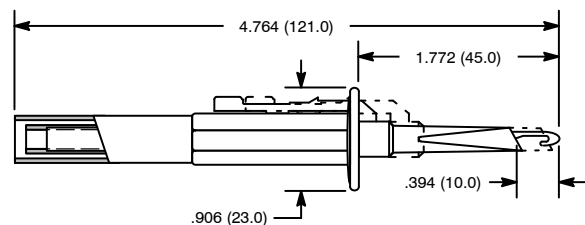

Specifications

IEC 1010 Rating: 1000V CAT3 / 600V CAT4 □ 20 Amps

Safety Plunger Clip Adapter, 4mm

Features

- Accepts All Industry Standard 4mm Test Lead Plugs
- 8-32 UNC Thread

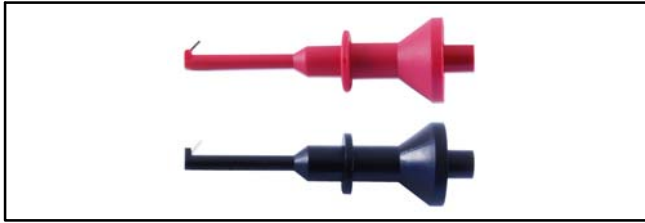

TL-026

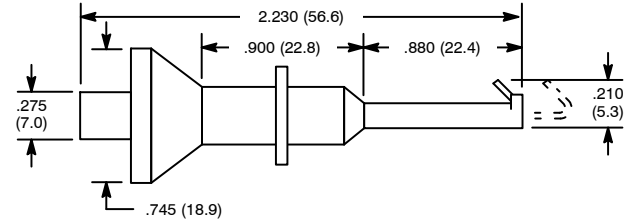

NTE Type No.	Color	Diag No.
72-177-0	Black	TL-026
72-177-2	Red	TL-026

Specifications

Rating: 1000V, 15 Amps

Insulated Plug-On Test Probe, 4mm

Features

- Accepts All Industry Standard 4mm Test Lead Plugs
- 8-32 UNC Thread



TL-027

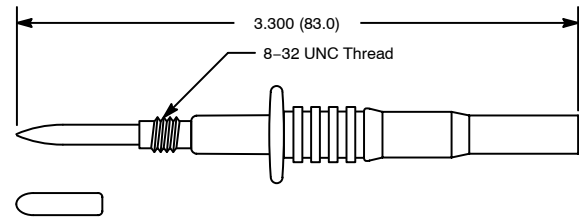

NTE Type No.	Color	Diag No.
72-178-0	Black	TL-027
72-178-2	Red	TL-027

Specifications

IEC 1010 Rating: 1000V, 20 Amps

Right Angle Insulated Plunger Hook Clip, 4mm

Features

- Accepts All Industry Standard 4mm Test Lead Plugs
- Fast and Easy Connection to Terminal and Component Test Leads



TL-028

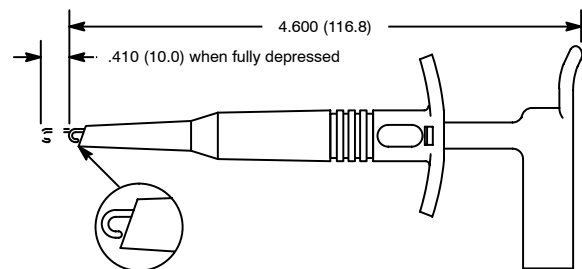

NTE Type No.	Color	Diag No.
72-180-0	Black	TL-028
72-180-2	Red	TL-028

Specifications

IEC 1010 Rating: 1000V, 15 Amps

4mm Panel Socket, 4.8mm Tab, Hex Nut

Features

- Fully Insulated
- Nickel Plated Contacts and Hardware
- Accepts Most Types of Shrouded and Unshrouded 4mm Plugs



TL-014

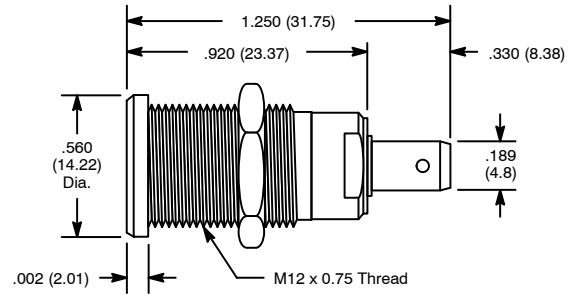

NTE Type No.	Color	Diag No.
72-037	Black	TL-014
72-038	Blue	TL-014
72-039	Green	TL-014
72-040	Red	TL-014
72-041	White	TL-014
72-042	Yellow	TL-014

Specifications

IEC 1010 Rating: 1000V CAT2 25 Amps
 Mounting Hole: .472" (12mm)

4mm Panel Socket, 4.8mm Tab, Push-In

Features

- Fully Insulated
- Nickel Plated Contacts and Hardware
- Accepts Most Types of Shrouded and Unshrouded 4mm Plugs



TL-015

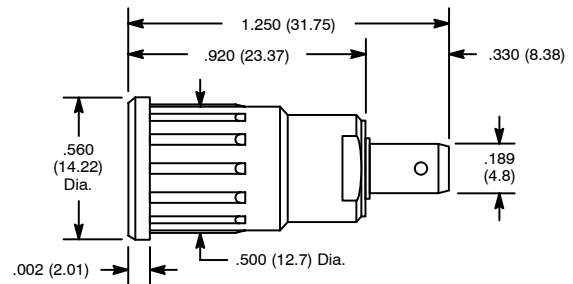

NTE Type No.	Color	Diag No.
72-043	Black	TL-015
72-044	Blue	TL-015
72-045	Green	TL-015
72-046	Red	TL-015
72-047	White	TL-015
72-048	Yellow	TL-015

Specifications

IEC 1010 Rating: 1000V CAT2 25 Amps
 Mounting Hole: .472" (12mm)

4mm Full Safety Spade Terminal

Features

- UL/CSA Compliant
- Accepts All Industry Standard 4mm Test Lead Plugs
- Tiered Spade Opening Accommodates a Variety of Test Point Sizes



NTE Type No.	Color	Diag No.
72-026	Black	TL-017
72-027	Red	TL-017
NEW 72-027-KIT	Contains 1 ea. of 72-026 & 72-027	

TL-017

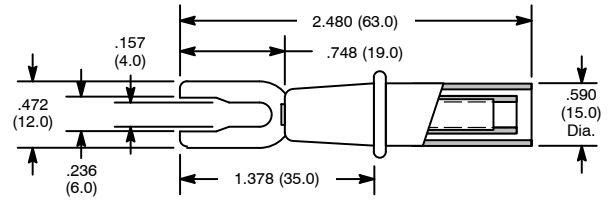

Specifications

IEC 1010 Rating: 1000V CAT3 / 600V CAT4 □ 20 Amps

4mm to 4mm Safety Plug Adaptor

Features

- Accepts All Industry Standard 4mm Test Lead Plugs
- Adapts Old Style Non Shrouded Sockets to Accept Full Safety Shrouded Plugs



NTE Type No.	Color	Diag No.
72-028	Black	TL-018
72-029	Red	TL-018
NEW 72-029-KIT	Contains 1 ea. of 72-028 & 72-029	

TL-018

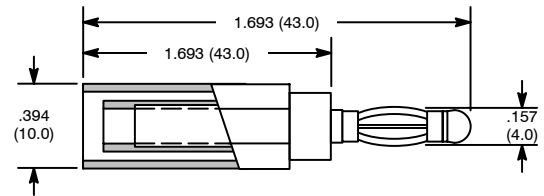

4mm to 4mm Coupler

Features

- Ideal for Connecting Two Test Leads Together
- Standard Colors: Black, Red



NTE Type No.	Color	Diag No.
72-051	Black	TL-020
72-052	Red	TL-020
NEW 72-052-KIT	Contains 1 ea. of 72-051 & 72-052	

TL-020

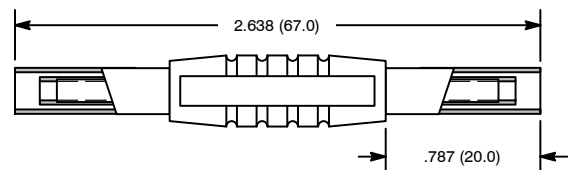

Specifications

IEC 1010 Rating: 1000V CAT3 □ 10 Amps

DIN Rail Terminal Test Adaptor

Features

- Enables DIN Rail Mounted Terminals to Accept 4mm Test Leads
- Adaptor Screws into Current Bar and Allows Easy and Convenient Access
- Uses M3 Thread Connection

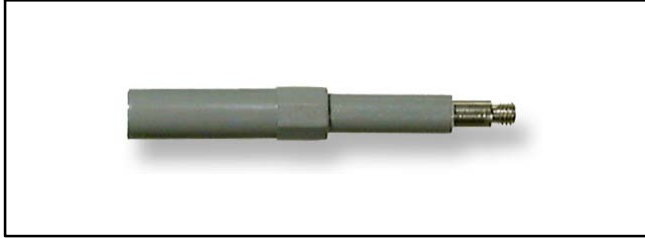

TL-019

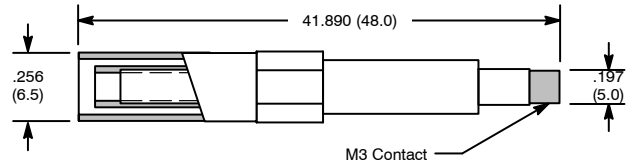

NTE Type No.	Color	Diag No.
72-030	Grey	TL-019

Fixed Shroud Plug, 4mm

Features

- Accepts Cable up to .177" (4.5mm) Dia.
- Standard Colors: Black, Red



NTE Type No.	Color	Diag No.
72-031	Black	TL-021
72-032	Red	TL-021

TL-021

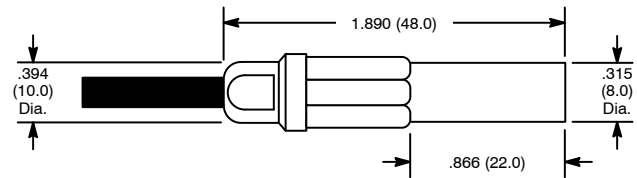

Specifications

IEC 1010 Rating: 1000V CAT3 20 Amps

Shutter Plug, 4mm

Features

- Accepts Cable up to .177" (4.5mm) Dia.
- Standard Colors: Black, Red



NTE Type No.	Color	Diag No.
72-033	Black	TL-022
72-034	Red	TL-022

TL-022

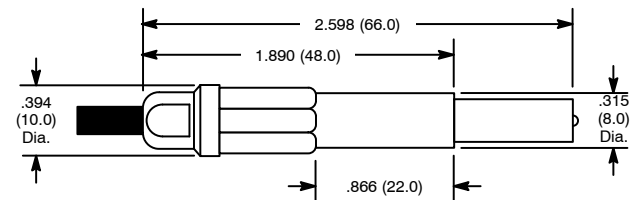

Specifications

IEC 1010 Rating: 1000V CAT3 20 Amps

Stackable Plug, 4mm

Features

- Accepts Cable up to .177" (4.5mm) Dia.
- Standard Colors: Black, Red



NTE Type No.	Color	Diag No.
72-061	Black	TL-023
72-062	Red	TL-023

TL-023

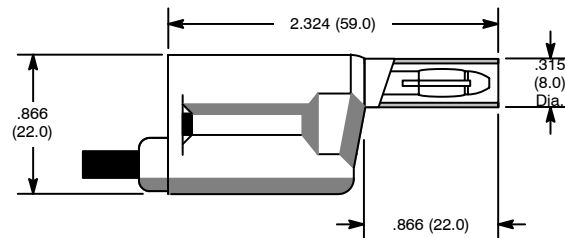

Specifications

IEC 1010 Rating: 1000V CAT3 20 Amps

Right Angle Plug, 4mm

Features

- Accepts Cable up to .177" (4.5mm) Dia.
- Standard Colors: Black, Red



NTE Type No.	Color	Diag No.
72-063	Black	TL-024
72-064	Red	TL-024

TL-024

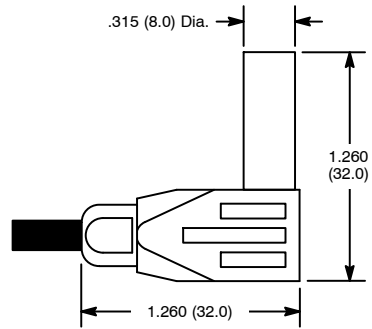

Specifications

IEC 1010 Rating: 1000V CAT3 □ 20 Amps

In Line Socket, 4mm

Features

- Accepts Cable up to .177" (4.5mm) Dia.
- Standard Colors: Black, Red



NTE Type No.	Color	Diag No.
72-035	Black	TL-025
72-036	Red	TL-025

TL-025

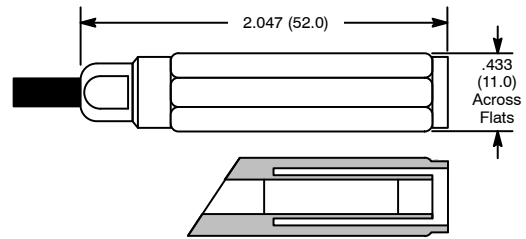

Specifications

IEC 1010 Rating: 1000V CAT3 □ 20 Amps

Cable Mountable Shrouded Banana Plug, 4mm

Features

- Nickel-Plated Brass Banana Plug with Nylon Insulator
- Allows For Quick and Easy Termination to Insulated Wire
- Standard Colors: Black, Red



NTE Type No.	Color	Diag No.
72-179-0	Black	TL-029
72-179-2	Red	TL-029

TL-029

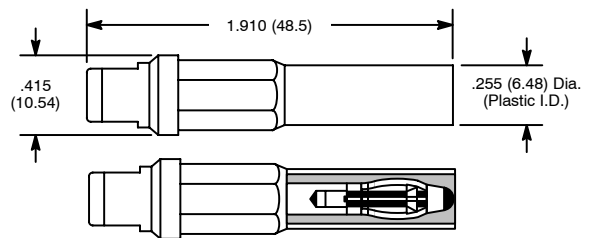

Specifications

IEC 1010 Rating: 1000V CAT3, 1500V CAT2, 20 Amps

NEW
NEW

Insulated Banana Coupler, 4mm

Features

- Nickel-Plated Brass Banana Plug with Nylon Insulator
- Mates with All Shrouded, Unshrouded and Retractable 4mm Banana Plugs
- Standard Colors: Black, Red



TL-030

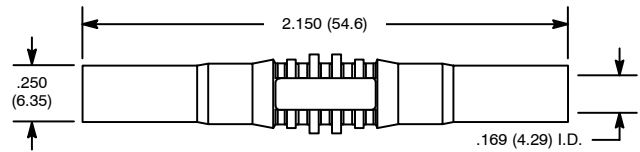

Specifications

IEC 1010 Rating: 1000V, 15 Amps

	NTE Type No.	Color	Diag No.
NEW	72-182-0	Black	TL-030
NEW	72-182-2	Red	TL-030

Multi-Pin Connector Test Lead Kit, Pro Edition

Features

- Packaged in a Rigid Plastic Case with Custom Foam Cut Outs which will Indicate if any of the Pins are Missing
- Modular, Quick-Change Interface Accommodates a Variety of Pin and Socket Sizes
- Compatible Connector Styles Included: MIL-C, D-SUB, XLR, PCB HEADER, INDUSTRIAL CIRCULAR, CPC, MULTI-PIN/MULTI-CIRCUIT and More

Description

Safety is often compromised when engineers are not given the correct tools to do the job required. Usually engineers improvise by collecting mating pins in little pots and use them to create an extended test point. Well there is now no need to take risks with this type of application. The new Multi-Pin Connector Test Kit allows tests to be done safely and quickly.

NTE Type No.	Kit Contains
72-072	1 Pair (Red & Black) of 48" (1.2m) Double Insulated Silicone Leads. Each lead is terminated on one end in a Right Angled 4mm Plug compatible with all standard 4mm instrument sockets, the other end is terminated in the unique "screw-in pin socket" 2 Sets of 4 Screw-In Pins. Each pin has both a male and female contact. 1 Green 48" (1.2m) Double Insulated Silicone Ground Lead. 1 Fully Insulated Large Green Crocodile Clip (Detachable, 4mm Banana Interface). 1 Set of Red and Black 3" (76mm) Extender Bars.



Specifications

IEC 1010 Rating: 1000V CAT2 / 600V CAT3 ☐

Journeyman Test Lead Kit

Features

- UL/CSA Compliant
- Compatible with All Industry Standard 4mm Instrument (DMM) Sockets
- Modular Test Leads Allow the User to Choose the Appropriate Accessory for Application

NTE Type No.	Kit Contains
72-074	1 Pair (Red & Black) of Modular, 48" (1.2m) Double Insulated Silicone Leads. Each lead is terminated on one end in a Straight Fixed Shrouded Plug, the other end is terminated in a Right Angle Plug. 1 Pair (Red & Black) of Large, Fully Insulated Crocodile Clips. 1 Pair (Red & Black) of Extra Sharp, Stainless Steel Probes. 1 Pair (Red & Black) Sprung Hooks 1 Pair Probe Tip Insulation Extenders 1 Tool Roll



Specifications

IEC 1010 Rating: 1000V CAT3 / 600V CAT4 ☐ 20 Amps

Comprehensive Test Lead Kit

Features

- UL/CSA Compliant
- Compatible with All Industry Standard 4mm Instrument (DMM) Sockets
- Modular Test Leads Allow the User to Choose the Appropriate Accessory for Application

NTE Type No.	Kit Contains
72-075	1 Pair (Red & Black) of Modular, 48" (1.2m) Double Insulated Silicone Leads. Each lead is terminated on one end in a Straight Fixed Shrouded Plug, the other end is terminated in a Right Angle Plug, both compatible with all standard 4mm instrument sockets. 1 Pair (Red & Black) of Large, Fully Insulated Crocodile Clips. 1 Pair (Red & Black) of Small, Fully Insulated Crocodile Clips (Note 1). 1 Pair (Red & Black) of Extra Sharp, Stainless Steel Probes. 1 Pair (Red & Black) Thin Spike Probes 1 Pair (Red & Black) Sprung Hooks 1 Pair Probe Tip Insulation Extenders 1 Tool Roll

Note 1. This item rated 300V CAT2 10 Amps



Specifications

IEC 1010 Rating: 1000V CAT3 / 600V CAT4 □ 20 Amps

Contractor's Choice Test Lead Kit

Features

- UL/CSA Compliant
- Compatible with All Industry Standard 4mm Instrument (DMM) Sockets

NTE Type No.	Kit Contains
72-089	1 Pair (Red & Black) of Modular, 48" (1.2m) Double Insulated Silicon Lead Assemblies 1 Pair (Red & Black) of Extra Sharp, Stainless Steel Probes 1 Pair (Red & Black) of Fully Insulated Crocodile Clips 1 Pair (Red & Black) of North American Line Power Receptacle Test Adaptors 1 Pair (Red & Black) of Sprung Hooks 1 Pair (Red & Black) of Probe Tip Insulation Extenders 1 Tool Roll



Specifications

IEC 1010 Rating: 1000V CAT3 / 600V CAT4 □ 20 Amps

Automotive Test Lead Kit

Features

- **Heat Resistant Silicone Leads can Withstand High Temperatures and Heat from such things as Hot Manifolds and Soldering Iron Tips**

Description

This high quality Test Lead Set has been designed with the automotive engineer in mind.

NTE Type No.	Kit Contains
72-073	<p>1 Pair (Red & Black) of Double Insulated Silicone Leads. Each lead is terminated on one end in a Straight Fixed Shrouded Plug, the other end is terminated in a Right Angle Plug, both compatible with all standard 4mm instrument sockets.</p> <p>1 Pair (Red & Black) of Large, Fully Insulated Crocodile Clips with wide jaw opening, ideal for battery terminals or Anderson clip connections.</p> <p>1 Pair (Red & Black) of Cable Piercers for intrusive measurement taking, ideal for when back probing is not an option.</p> <p>1 Pair (Red & Black) of Slim Back Probing Probes. These incorporate a "Spring Steel" prod which allows greater flexibility and less damage when attempting to override the rubber seal on some connections</p> <p>1 Tool Roll</p>



Deluxe Automotive Test Lead Set

Features

- **Packed in a Hard Case using a Closed-Cell Foam**

NTE Type No.	Kit Contains
72-079	<p>2 Pairs (Red & Black) of Silicone Insulated Test Leads</p> <p>1 Pair (Red & Black) of Couplers, used in connecting a pair of test leads so as to extend the reach</p> <p>1 Pair (Red & Black) of Fully Insulated Crocodile Clips</p> <p>1 Pair (Red & Black) of Cable Piercers</p> <p>1 Pair (Red & Black) of Bed of Nails Clips</p> <p>1 Pair (Red & Black) Thin Back Probing Probes</p> <p>1 In Line Fuse Link</p>



Easy Access Scope Series Back Probe Kit

Features

- Compatible with All Standard 4mm Instrument Sockets

NTE Type No.	Kit Contains
72-091	4 Color Coded (Yellow, Red, Blue, & Green) 76" (2m) High Quality Double Insulated Silicone Test Leads 4 Color Coded (Yellow, Red, Blue, & Green) Extra Thin Back Probing Pins .028" (0.7mm) OD 1 Tool Roll

Specifications

IEC 1010 Rating: 1000V CAT3 □ 20 Amps (Except Back Probe Pins)

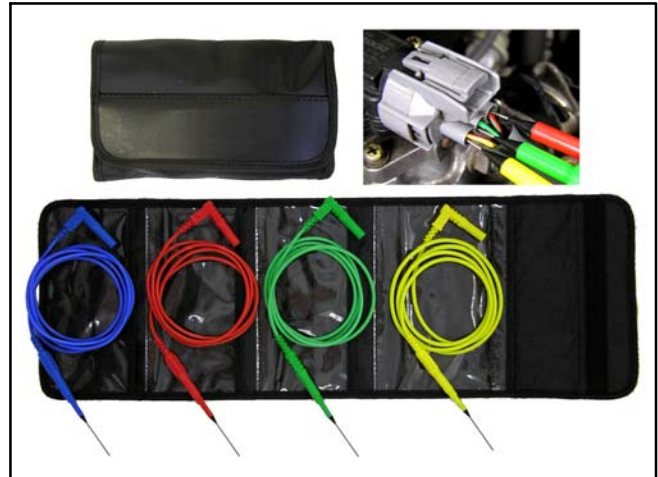

Easy Access Back Probe Kit

Features

- Compatible with All Standard 4mm Instrument Sockets

NTE Type No.	Kit Contains
72-092	2 High Visibility (Yellow & Green) 76" (2m) High Quality Double Insulated Silicone Test Leads 4 Color Coded (2 Yellow & 2 Green) Extra Thin Back Probing Pins .028" (0.7mm) OD 1 Tool Roll

Specifications

IEC 1010 Rating: 1000V CAT3 □ 20 Amps (Except Back Probe Pins)



Bed Of Nails Cable Assembly Kit

Features

- Ideal for Telecom Applications
- Accepts All Standard 4mm Plugs, Shrouded or Un-Shrouded

Description

One end of the lead is terminated in a "Bed of Nails" crocodile clip which also has a single cable piercing spike within the jaw configuration. The other end is made up of 4mm cable socket which is capable of accepting all standard 4mm plugs whether shrouded or un-shrouded.

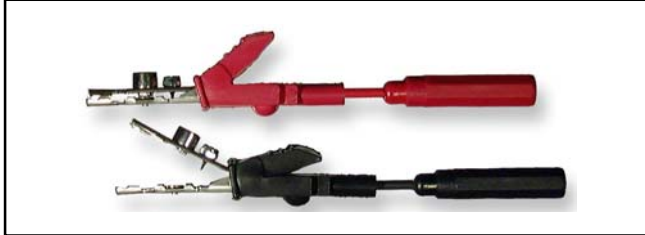

NTE Type No.	Kit Contains
72-080	1 Red and 1 Black Cable Assembly utilizing double insulated silicone cable, the inner skin being of a bright contrasting color other than that of the outer, acting as a wear indicator.

TL-027

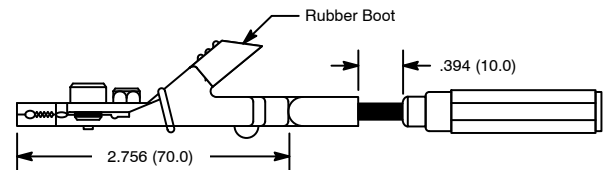

Specifications

Maximum Jaw Opening: 1.181" (30mm)

Back Probing Probes

Features

- Spring Steel Probe Allows Greater Probing Flexibility

Description

These probes incorporate a "spring steel" probe which allows greater flexibility and less damage when attempting to override the rubber seat on some connectors.



NTE Type No.	Contains
72-100	1 Pair (Red & Black) of Slim Back Probing Probes

TL-028

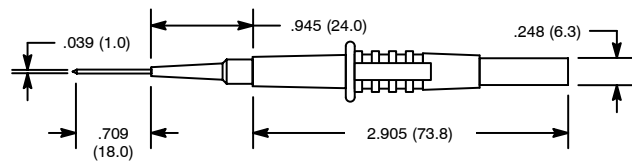

Specifications

IEC 1010 Rating: 1000V CAT3

Replacement Fuses

Features

- 2 Different Values for Fused Leads and Probes

NTE Type No.	Rating	UL/CSA Compliant
72-001	10A/600V/50kA	No
72-002	500mA/1000V/50kA	Yes

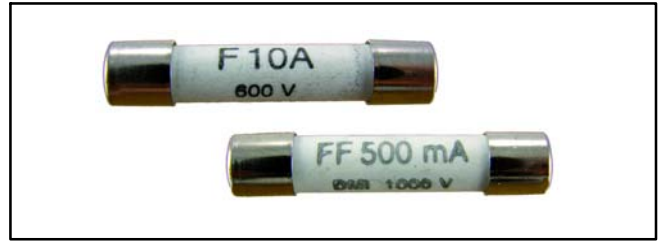

Spare Pins, Multi Pin Pairs

Features

- Available in 4 Different Sizes: Mini, Small, Medium, and Large
- For use with 72-072 Multi Pin Connector Test Lead Kit

NTE Type No.	Size	Description
72-082	Mini	Each pair of Screw-In Pins has both a male and female contacts. Ideal for use with the 72-072 Multi-Pin Connector Test Lead Kit
72-083	Small	
72-084	Large	
72-101	Medium	



Easy Access Back Probe Replacement Pack

Features

- .028" (0.7mm) OD Back Probe Pins
- Supplied in a Protective Plastic Tube

Description

Perfect for connecting to fuel injectors, MAP and TPS sensors, as well as any weather pack seal type connectors, the modular design of these probes is compatible with any industry-standard, 4mm plug whether shrouded or not.

NTE Type No.	Pack Contains
72-086	1 Red and 1 Black Back Probe. Ideal for use with the 72-073 Automotive Test Lead Kit
72-087	1 Yellow, 1 Red, 1 Blue, and 1 Green Back Probe. Ideal for use with the 72-091 Back Probe Kit
72-088	2 Yellow and 2 Green High Visibility Back Probes. Ideal for use with the 72-092 Back Probe Kit

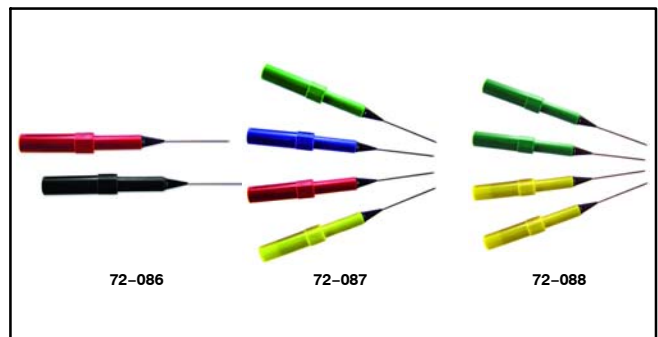

Test Lead Organizer

Features

- Black Quad-Fold Organizer

NTE Type No.	Description
72-009	4 Pocket Test Lead Organizer



Multi-Color Insulated Lead Set

Features

- Overall Length: 17.72" (.450 Meter)
- Clip Jaw Opening: .320" (8.13mm)

NTE Type No.	Contains
72-111	2 Black, 2 Red, 2 Yellow, 2 Green and 2 White Jumper Leads



Grounding Clamp, Steel, 50 Amp

Features

- Zinc Plated Clamp
- Accepts Round Stock up to 1.375" (34.9mm) O.D.
- Screw Connection
- Overall Length: 2.500" (63.5mm)

NTE Type No.	Description
72-147	Grounding Clamp, Steel



Silicone Cable

Features

- Multistranded Very Flexible Copper Core
- Wire Gauge: 18AWG
- Double Skin Silicone Insulated
- Bi-Colored Layers

NTE Type No.	Length (Feet / Meters)	Color	Quantity
72-003	328 / 100	Black	1 Roll
72-003-12	1 / .304	Black	10 Pieces
72-004	328 / 100	Blue	1 Roll
72-004-12	1 / .304	Blue	10 Pieces
72-005	328 / 100	Green	1 Roll
72-005-12	1 / .304	Green	10 Pieces
72-006	328 / 100	Red	1 Roll
72-006-12	1 / .304	Red	10 Pieces
72-007	328 / 100	White	1 Roll
72-007-12	1 / .304	White	10 Pieces
72-008	328 / 100	Yellow	1 Roll
72-008-12	1 / .304	Yellow	10 Pieces



Specifications

Cable Size: 1.0mm² c.s.a. .142" (3.6mm) Dia. Nom. o/a

Wire Gauge: 18AWG

Multistranded Copper Core: 7/36/0.071

IEC1010 Rating: 1000 Volts CAT3 ☐ 20 Amps

Temperature Rating: -10° to +150°C

Extension Cable Reel

Features

- Compatible with All Industry Standard 4mm Instrument Sockets & Banana Plug Terminated Test Leads/Probes
- Double Insulated, Bi-Color Silicone Cable Boasts 250+ Copper Strands for Maximum Flexibility and Overall Performance
- Bi-Color Insulation Design Alerts User if Exposed Conductor Shock Hazard is Imminent

NTE Type No.	Color	Description
72-085	Red	Reel contains just over 40 Feet (12 Meters) of Highly Flexible, Double Skinned Silicone Cable. One end of the lead is terminated in a 4mm Right Angled Plug, the other has a 4mm socket into which the original lead is plugged.
72-102	Black	

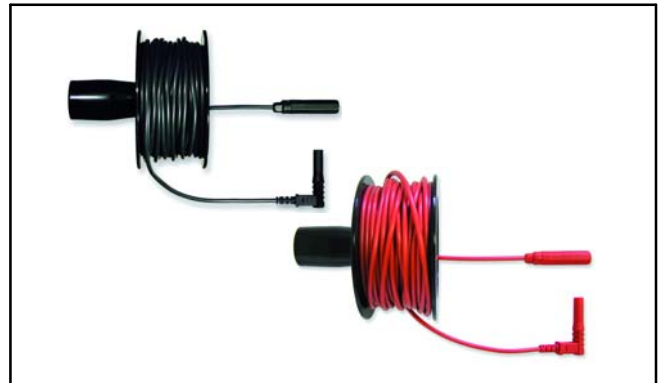

Specifications

IEC 1010 Rating: 1000V CAT3 / 600V CAT4 ☐ 20 Amps

Special Cross Reference Notes

\$ Insulator sold separately.

@ Original is right angle, replacement is straight.

Cross Reference by Manufacturer

FROM MUELLER TO SILVERTRONIC

Test Lead/Clip to be Replaced	NTE Replacement	Test Lead/Clip to be Replaced	NTE Replacement	Test Lead/Clip to be Replaced	NTE Replacement	Test Lead/Clip to be Replaced	NTE Replacement
BU-32603-0	72-179-0	72-BU46PR-0	72-142-0	PHILMETRIC		HL-25C	72-118
BU-32603-2	72-179-2	72-BU46PR-2	72-142-2	SA22	72-111	HL-27	72-117
JP8681-0	72-166-0	72-BU47-2	72-143-2			HL-27C	72-118
JP8681-2	72-166-0	72-BU49-0	72-146-0			HL-30	72-123
JP8681-4	72-166-4	72-BU49-2	72-146-2	POMONA		HL-30BL	72-124
				23777A-0	72-026	HL-30C	72-125
JP8681-5	72-166-5	72-BU58	72-147	23777A-2	72-027	HL-31-BLACK	72-127-0
JP8681-6	72-166-6	72-BU58-0	72-143-0	25519A	72-068	HL-31-BLUE	72-127-6
JP8681-9	72-166-9	72-BU60	72-148	25787A-0	72-055	HL-31-GREEN	72-127-5
JP-8681-0	72-166-0	72-BU60C	72-149	25787A-2	72-056	HL-31-RED	72-127-2
JP-8681-2	72-166-2	72-BU60C5	72-151				
				25906A	72-019	HL-31-WHITE	72-127-9
JP-8681-4	72-166-4	72-BU60CH5-0	72-150-0	25907A	72-067	HL-31-YELLOW	72-127-4
JP-8681-5	72-166-5	72-BU60CHS-2	72-150-2	25908A	72-066	HL-41A	72-133
JP-8681-6	72-166-6	72-BU60HS-0	72-152-0	25911B	72-016	HL-41C	72-134
JP-8681-9	72-166-9	72-BU60HS-2	72-152-2	25914-0	72-053	HL-43PR-BLACK	72-135-0
JP-8783-L	72-167	72-BU60S	72-153				
				25914-2	72-054	HL-43PR-RED	72-135-2
JP-8783-N	72-168	72-BU60TBO	72-154	26042B-0	72-057	HL-45	72-136
010003	72-120-KIT3	72-BU60U	72-155	26042B-2	72-058	HL-45C	72-137
010004	72-123-KIT3	72-BU60X	72-156	26232A	72-011	HL-46A	72-140
010005	72-125-KIT3	72-BU62-0	72-157-0	26252	72-052	HL-46C	72-141
010006	72-129-KIT	72-BU62-2	72-157-2				
				26366	72-069	HL-46PR-BLACK	72-142-0
010007	72-130-KIT	72-BU63-0	72-158-0	26383-0	72-031	HL-46PR-RED	72-142-2
010008	72-136-KIT	72-BU63-2	72-158-2	26383-2	72-032	HL-47	72-132-KIT
010009	72-144-KIT	72-BU70	72-159	26384-0	72-035	HL-47-BLACK	72-132-0
010010	72-149-KIT	72-BU70C	72-160	26384-2	72-036	HL-47-RED	72-132-2
010011	72-150-KIT	72-BU72-0	72-161-0				
				26411	72-088	HL-48B	72-144
010012	72-151-KIT	72-BU72-2	72-161-2	26479	72-050	HL-48C	72-145
010013	72-152-KIT	72-BU75K	72-162	26481	72-072	HL-60	72-148
010014	72-153-KIT	72-BU87-0	72-165-0	26580-12	72-081	HL-60C	72-149
010015	72-163-KIT	72-BU87-2	72-165-2	26721-0	72-061	HL-60CHS-BLACK	72-150-0
010016	72-158-KIT	72-BU102W-0	72-112-0				
				26721-2	72-062	HL-60CHS-RED	72-150-2
010017	72-123	72-BU102W-2	72-112-2	26723	72-097	HL-60CS	72-151
010018	72-125	72-BU250	72-118	26727	72-093	HL-60HS-BLACK	72-152-0
010019	72-129	72-BU270	72-121	26729-0	72-063	HL-60HS-RED	72-152-2
010022	72-144	72-BU340	72-130	26729-2	72-064	HL-60S	72-153
010024	72-151	72-BU-00287	72-111				
				26733-0	72-003	HL-70	72-159
010025	72-153	72-BU-30TBO	72-126	26733-2	72-006	HL-70C	72-160
010030	72-120	72-BUB5	72-163	2122505A	72-033	HL-72-BLACK	72-161-0
010032	72-138-KIT	72-BUB5C	72-164	2122506A	72-034	HL-72-BLUE	72-161-6
010037	72-154-KIT	72-JP8681-0	72-166-0			HL-72-GREEN	72-161-5
080121	72-111	72-JP8681-2	72-166-2				
						HL-72-RED	72-161-2
				PROBE MASTER		HL-72-WHITE	72-161-9
NTE		72-JP8783L	72-167	8017S	72-068	HL-72-YELLOW	72-161-4
72-BU00287	72-111	72-JP8783N	72-168	9153-0	72-010	HL-72CPN	72-114
72-BU4BB	72-144			9153-2	72-011	HL-85	72-163
72-BU4BC	72-145			9154-0	72-020		
72-BU21A	72-114			9154-2	72-021	HL-85C	72-164
72-BU23-0	72-115-0	OLDAKER				HL-87-BLACK	72-165-0
		149	72-148	9157-0	72-053	HL-87-BLUE	72-165-6
72-BU23-2	72-115-2	149-2	72-154	9157-2	72-054	HL-87-GREEN	72-165-5
72-BU24A	72-116	170	72-144	9160-0	72-051	HL-87-RED	72-165-2
72-BU25	72-117	170-1	72-120	9160-2	72-052		
72-BU26-0	72-119-0	170-1C	72-121	9163-0	72-080	HL-87-WHITE	72-165-9
72-BU26-2	72-119-2					HL-87-YELLOW	72-165-4
				9163-2	72-080	HLMB200	72-167
72-BU27	72-120	170-2	72-117	9169-0	72-016	HLMB200-B-T-U	72-167
72-BU29-0	72-122-0	170-2C	72-118	9169-2	72-017	HLMB-225-BLACK	72-166-0
72-BU29-2	72-122-2	170-3	72-113	9176	72-009		
72-BU30	72-123	170-3C	72-114			HLMB-225-RED	72-166-2
72-BU30BL	72-124	170C	72-145			SAT-100	72-111
						SAT-105	72-111
72-BU30C	72-125	183B	72-006	SAYE INDUSTRY			
72-BU31-0	72-127-0	226	72-157-2	HL-11APN	72-174	SEMICONDUCTOR	
72-BU31-2	72-127-2	249	72-124	HL-11APS	72-174	72-BU46A-0	72-138-0
72-BU32-0	72-128-0	277A	72-127-2	HL-11CPN	72-173	72-BU46A-2	72-138-2
72-BU32-2	72-128-2	486-6	72-097	HL-11CPS	72-173		
				HL-13-BLACK	72-176-0		
						SILVERTRONIC	
72-BU34	72-129	518-6	72-068	HL-13-BLUE	72-176-6	40001B-R	72-143-2
72-BU34C	72-130	518-11	72-069	HL-13-GREEN	72-176-5	40020-B	72-115-0
72-BU36-0	72-131-0	668	72-163	HL-13-RED	72-176-2	116037	72-001
72-BU36-2	72-131-2	680	72-165-2	HL-13-WHITE	72-176-9	116048	72-002
72-BU40A-0	72-132-0	684	72-146-2	HL-13-YELLOW	72-176-4	116901/B	72-003
72-BU40A-2	72-132-2	684-1	72-122-2	HL-21APN	72-113	116901/BL	72-004
72-BU41A	72-133	684-2	72-119-2	HL-21APS	72-113	116901/G	72-005
72-BU41C	72-134	684-3	72-115-2	HL-21CPS	72-114	116901/R	72-006
72-BU43PR-0	72-135-0	815	72-168	HL-23-BLACK	72-115-0	116901/W	72-007
72-BU43PR-2	72-135-2	815-1	72-166-2	HL-23-BLUE	72-115-6	116901/Y	72-008
72-BU45	72-136	826	72-034	HL-23-GREEN	72-115-5	119503QDF	72-009
72-BU45C	72-137	833	72-111	HL-23-RED	72-115-2	121012/B	72-010
72-BU46A-033Z	72-139	944-4	72-017	HL-23-WHITE	72-115-9	121012/R	72-011
72-BU46A-Z1ZZ	72-140	946	72-019	HL-23-YELLOW	72-115-4	121017/B	72-012
72-BU46C-023Z	72-141	2522	72-062	HL-25	72-117	121017/R	72-013

Cross Reference by Manufacturer

FROM SILVERTRONIC TO WAVETEK

Test Lead/Clip to be Replaced	NTE Replacement	Test Lead/Clip to be Replaced	NTE Replacement	Test Lead/Clip to be Replaced	NTE Replacement	Test Lead/Clip to be Replaced	NTE Replacement
121019/B	72-014	126024/R	72-058	400016-B	72-127-0	501958	72-147
121019/R	72-015	126060/B	72-059	400016-R	72-127-2	501993-B	72-158-0
121026/B	72-016	126060/R	72-060	400017-B	72-157-0	501993-R	72-158-2
121026/R	72-017	128005/B	72-061	400017-R	72-157-2	501994	72-136
121033/B	72-018	128005/R	72-062	400018-B	72-143-0	501994C	72-137
121033/R	72-019	128010/B	72-063	400018-R	72-143-2	501995	72-163
121039/B	72-020	128010/R	72-064	400019-B	72-146-0	501995C	72-164
121039/R	72-021	129272	72-065	400019-R	72-146-2	501996	72-120
121280/B	72-022	129300	72-066	400020-B	72-115-0	501996C	72-121
121280/R	72-023	129301	72-067	400020-R	72-115-2	501997	72-117
121328/B	72-024	129303/OR	72-068	400021-B	72-165-0	501997C	72-118
121328/R	72-025	129303/OS	72-069	400021-R	72-165-2	501999	72-098
123017/R	72-056	129305/OR	72-070	400022-B	72-122-0	502000-B	72-152-0
124000/B	72-026	129305/OS	72-071	400022-R	72-122-2	502000-R	72-152-2
124000/R	72-027	129429	72-175	400023-B	72-119-0	502000C-B	72-150-0
124044/B	72-028	129439	72-072	400023-R	72-119-2	502000C-R	72-150-2
124044/R	72-029	129514	72-073	400024-B	72-161-0	502001	72-162
124046	72-030	129525	72-074	400024-R	72-161-2	502002	72-116
125037/5B	72-031	129526	72-075	400025-B	72-131-0	502002P	72-116PS
125037/5R	72-032	129528	72-076	400025-R	72-131-2	502003-B	72-112-0
125041/5B	72-033	131139	72-077	501774	72-139	502003-R	72-112-2
125041/5R	72-034	131370/OR	72-078	501774C	72-141	502004-B	72-094
125046/5B	72-035	131483	72-079	501774Z	72-140	502004-R	72-095
125046/5R	72-036	134312	72-080	501784	72-148	502005	72-159
125048/B	72-037	134313	72-100	501784C	72-149	502005C	72-160
125048/BI	72-038	134316	72-081	501784CS	72-151	502007	72-126
125048/G	72-039	134323	72-082	501784S	72-153	502008	72-129
125048/R	72-040	134324	72-083	501784U	72-155	502008C	72-130
125048/W	72-041	134325	72-101	501784X	72-156	502009-B	72-132-0
125048/Y	72-042	134326	72-084	501785	72-154	502009-R	72-132-2
125050/B	72-043	134328/B	72-102	501789	72-111	503011C	72-173
125050/BI	72-044	134328/R	72-085	501790	72-113	503011CP	72-173PS
125050/G	72-045	134382	72-086	501790C	72-114	905232	72-089
125050/R	72-046	134388	72-087	501790CP	72-114PS	905239	72-090
125050/W	72-047	134390	72-088	501790P	72-113PS	905266	72-091
125050/Y	72-048	400010B	72-142-0	501791	72-168	905267	72-092
125072/B	72-049	400010R	72-142-2	501791-L	72-167	905269	72-093
125072/R	72-050	400012B	72-135-0	501792	72-096	905270	72-097
125099/B	72-051	400012R	72-135-2	501793	72-123		
125099/R	72-052	400013-B	72-166-0	501793C	72-125		
126009/B	72-053	400013-R	72-166-2	501795	72-124	TRIPLETT	
126009/R	72-054	400014-B	72-099B	501797	72-144	79-564	72-097
126017/B	72-055	400014-R	72-099R	501797C	72-145	WAVETEK	
126017/R	72-056	400015-B	72-128-0	501849	72-133	TL244	72-097
126024/B	72-057	400015-R	72-128-2	501849C	72-134	TL245	72-068